

Optical Fiber Glossy Object Sensor

E3X-NL

Utilization lightwave technology has innovated glossiness detection. OMRON's glossy object sensor can discriminate a wide variety of glossiness differences. The fiber-optic system has achieved the small, non-contact models.



Features

Employs OMRON's unique FAO (Free Angle Optics) technology which enables delicate sensing of object glossiness without influence from colors and patterns. Transparent films on boxes and labels on transparent films can be detected.

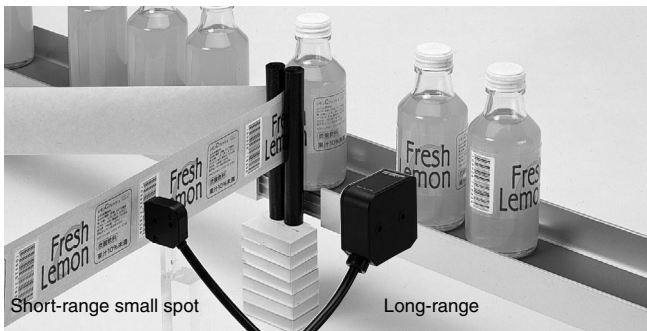

Two different types of fiber heads meet a wide range of applications.

Two different fiber heads are available.

According to applications, you can choose the short-distance, small spot type ideal for detection of small objects or the long-distance type that can perform in-line standard detection.

Short-distance, small spot type

E32-S15-1/-2

Ideal for precision detection and small object detection.

Long-distance type

E32-S15L-1/-2

Resistant to object shake and enables in-line standard detection.

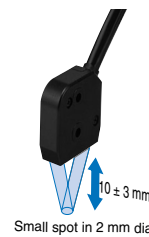

The teaching system ensures easy adjustment just by pressing the button.

- Adjustment man-hour saving type requiring only a one-time pressing of the button
- Teaching system only requires to push the button, ensuring sensitivity adjustment without individual differences.



Adopts the pulse-ON system that is insensitive to disturbance light

The emitter (red LED) in the fiber head uses a pulse-ON system to minimize the influence of disturbance light. The Sensor provides stable sensing characteristics if disturbance light occurs from fluorescent lamps in-line.



Application

Short-distance, small spot type

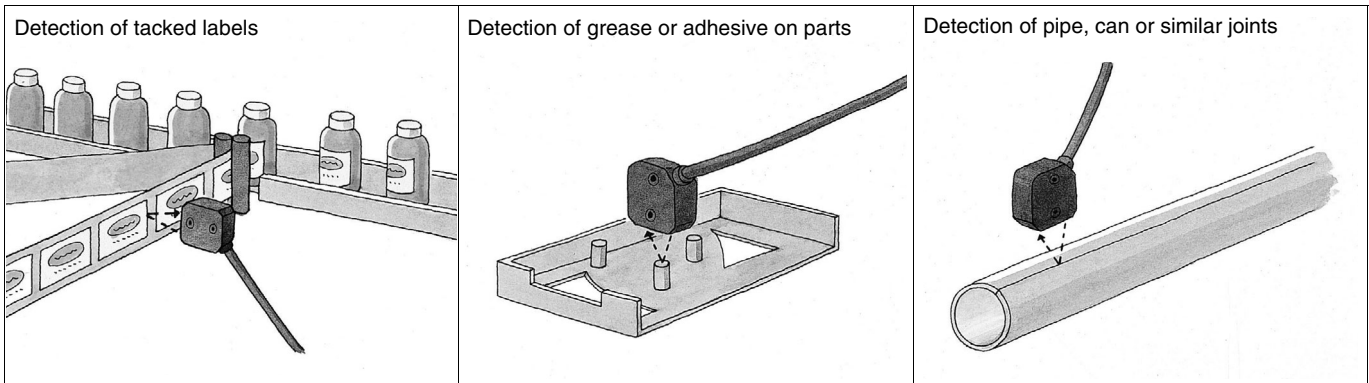

Long-distance type

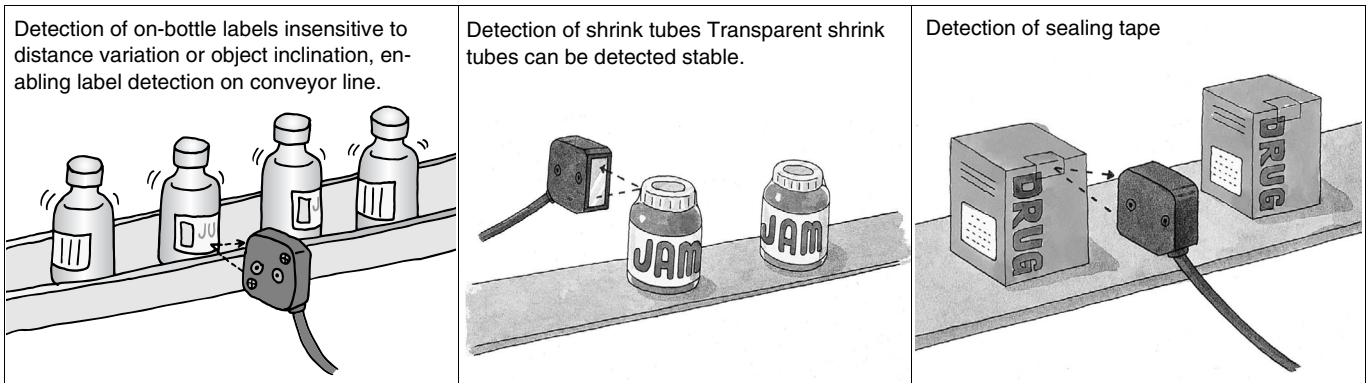

Features

Principles for Glossiness Detection by FAO

First, the light from a red LED passes through a polarizing filter so only the S wave is emitted. If the detectable object is glossy, the S wave is reflected regularly and is transmitted as is to the Fiber Receiver 1. If the detectable object is not glossy, there is more diffuse reflection, thus the polarization direction is randomized and a P wave is generated. The S and P waves are divided by the FAO (special polarized beam splitter), the waves travel to their respective fiber receivers, and the variation in the glossiness is determined by comparing the two received signals.

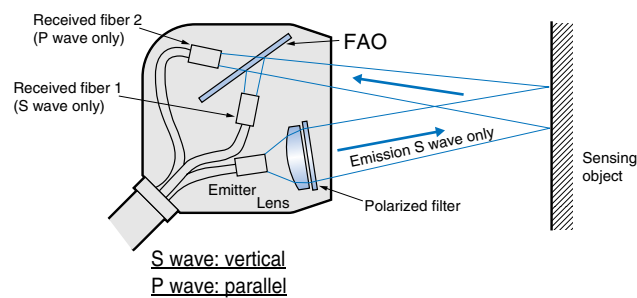

Fuzzy Teaching Function Backs up Stable Detection

Supported by the fuzzy teaching function if objects have no difference in glossiness. If the glossiness difference goes below the minimum sensing level, the microprocessor in the amplifier determines the discrimination means automatically. Sensed by light energy difference like an ordinary mark sensor. (When 2-point teaching is selected)

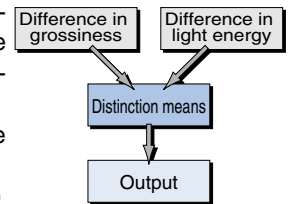

Measures against Double Refraction

There are transparent films and transparent plastic objects that change the direction of polarized light when it passes through the transparent films and transparent plastic objects. This is called double refraction. Using the optional rotary mounting bracket (E39-L109), the sensor unit can be inclined 45 degrees to take measures against double refraction. (Example) Metal cylindrical object coated with transparent film

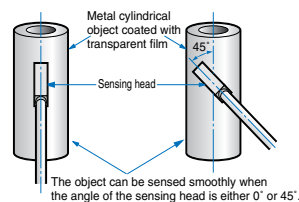

Ordering Information

Sensors

Amplifier Units

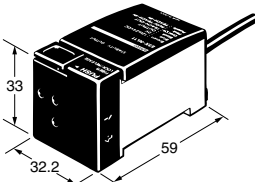
Connection method	Shape	Model
Pre-wired type		E3X-NL11

Fiber Units

 Red light

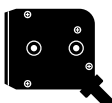
Sensor type	Shape	Sensing distance	Fiber length	Model
Reflective model		10 ± 3 mm	0.5 m	E32-S15-1
			1 m	E32-S15-2
		20 ± 7 mm	0.5 m	E32-S15L-1
			1 m	E32-S15L-2

Accessories (Order Separately)

Mounting Brackets

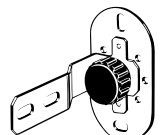
Shape	Model	Quantity	Remarks
	E39-L109	1	Can be used with the fiber unit E32-S15-□. Mounting bracket variable in rotary angle (0°, 45°) for stable detection of transparent films (double-refractive objects) on glossy objects such as metal or glass plates.

Covers

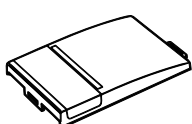
Shape	Model	Quantity	Remarks
	E39-G9	1	Attached to the amplifier unit E3X-NL11. Please place an order when the protective cover is damaged or lost.

Rating/Performance

Amplifier Units

Item	Model	E3X-NL11
Light source (wave length)		Red LED (680 nm)
Power supply voltage		12 to 24 VDC \pm 10%, ripple (p-p) : 10% max.
Current consumption		100 mA max.
Control output		Load supply voltage 30 VDC max., load current 100 mA max. (residual voltage 1 V max.) Open collector output type (NPN output) Light-ON/Dark-ON switch selectable
Answer-back output		Load power supply voltage 30 VDC max., load current 100 mA max. (residual voltage 1 V max.) Open collector output type (NPN output)
Remote teaching input		Purple and blue (0 V) are connected when remote input turns ON: 0 V short-circuit current 1 mA max. Purple and blue (0 V) are disconnected when remote input turns OFF: Open or 9 V min. (max. input voltage 24 V). Note that the input is valid only when remote RUN/TEACH selection input (across pink-blue) is provided.
Protective circuits		Protection from load short-circuit and reversed power supply connection
Response time		Operation or reset: 1 ms max.
Sensitivity adjustment		Teaching system
Timer function *		OFF-delay fixed at 40 ms
Ambient illuminance		Incandescent lamp: 3,000 lux max. Sunlight 10,000 lux max.
Ambient temperature		Operating: -25°C to 55°C, Storage: -40°C to 70°C (with no icing or condensation)
Ambient humidity		Operating: 35% to 85% RH, Storage: 35% to 95% RH (with no icing or condensation)
Insulation resistance		20 M Ω min. at 500 VDC
Dielectric strength		1,000 VAC at 50/60 Hz for 1 minute
Vibration resistance		10 to 55 Hz, 1.5-mm double amplitude or 300 m/s ² (approx. 30G) for 2 hrs each in X, Y, and Z directions
Shock resistance		Destruction: 500 m/s ² for 3 times each in X, Y, and Z directions
Protective structure		IEC 60529 IP50 (with Protective Cover attached)
Connection method		Pre-wired models (standard length: 2 m)
Weight (Packed state)		Approx. 200 g
Material	Case	PBT (polybutylene terephthalate)
	Cover	Polycarbonate
	Mounting Brackets	Stainless steel (SUS304)
Accessories		Mounting bracket, instruction manual

* The OFF-delay timer can be reset by setting the switch.

Fiber Units

Item	Sensing method Features Model	Reflective model			
		Short-range small spot		Long-range	
		E32-S15-1	E32-S15-2	E32-S15L-1	E32-S15L-2
Sensing distance		10 \pm 3 mm (white paper, white glossy plastic 40x20 mm)		20 \pm 7 mm (white paper, white glossy plastic 40x20 mm)	
Min. sensing object		0.5-mm		2-mm	
Sensing object angle		Glossiness determination is possible at 4° inclination from the mounting hole (at sensing distance of 10 mm)		Glossiness determination is possible at 7° inclination from the mounting hole (at sensing distance of 20 mm)	
Spot diameter		Approx. 2-mm dia./approx. 2-mm dia. (at sensing distance of 10 mm)		Approx. 15-mm dia./approx. 4-mm dia. (at sensing distance of 20 mm)	
Ambient temperature		Operating: -25°C to 55°C, Storage: -40°C to 70°C (with no icing or condensation)			
Ambient humidity		Operating: 35% to 85%RH, Storage: 35% to 90% RH (with no condensation)			
Permissible bending radius		4 mm min.			
Protective structure		IEC 60529 IP50			
Fiber length		500 mm	1 m	500 mm	1 m
Weight (Packed state)		Approx. 50 g	Approx. 60 g	Approx. 80 g	Approx. 90 g
Material	Sensor case	Heat-resistant ABS resin			
	Sensor window	transparent glass		Acrylics	
	Fiber cladding	urethane			

Characteristic data (typical)

Glossiness vs. Operating Range (Typical) Glossiness vs. Angle (Typical)

E3X-NL11 with E32-S15-□

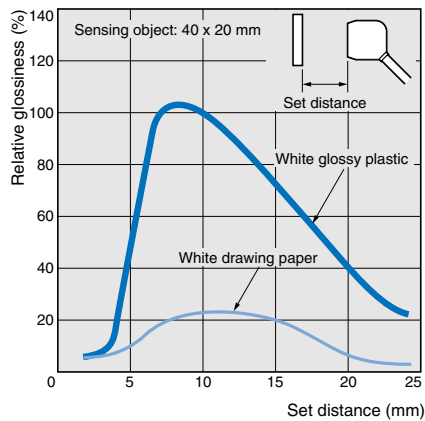

E3X-NL11 + E32-S15-□ (X direction)

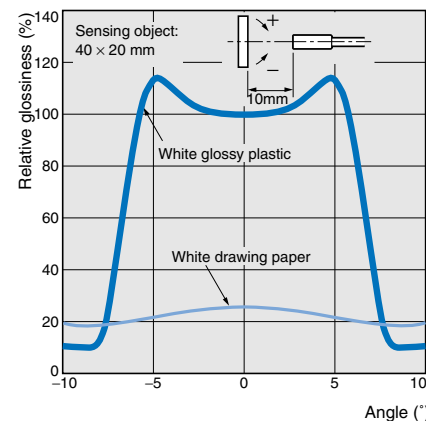

E3X-NL11 + E32-S15L-□ (X direction)

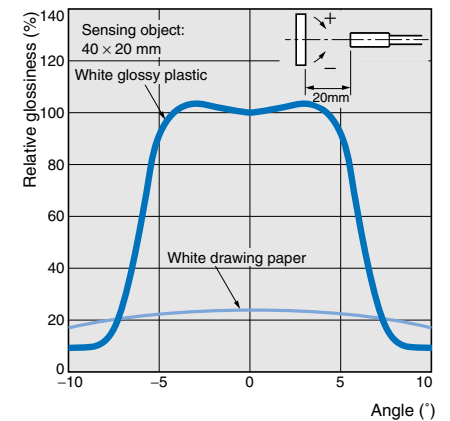

E3X-NL11 with E32-S15L-□

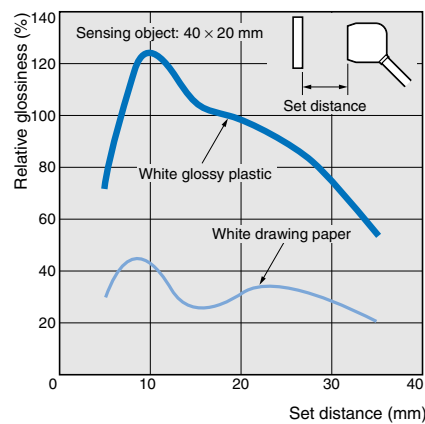

E3X-NL11 + E32-S15-□ (Y direction)

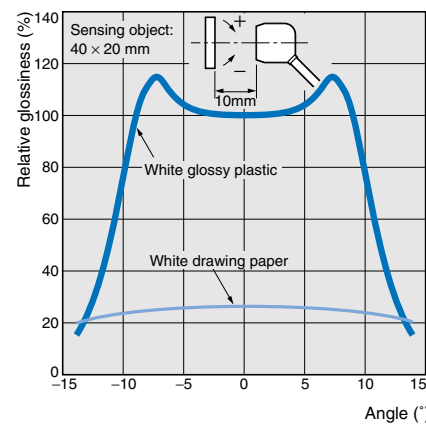

E3X-NL11 + E32-S15L-□ (Y direction)

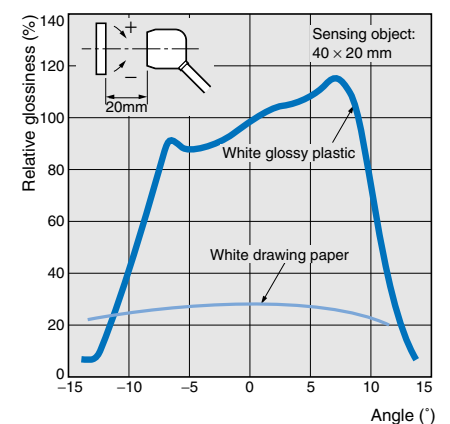

Output Circuit Diagram

NPN output

Model	Output transistor Status	Timing chart	Mode selection switch	Output circuit
E3X-NL11	Light ON	<p>T: OFF delay timer The change for 0 or 40ms (fixed) is possible.</p>	L ON	
	Dark ON	<p>T: OFF delay timer The change for 0 or 40ms (fixed) is possible.</p>	D ON	

Technical Guide

Glossiness

When light is applied to the sensing object, the reflected light is generally a mixture of regular reflection components and diffuse reflection components. Glossiness is directly proportional to the light intensity of the regular reflection components. In JIS, the glossiness of a glass plate surface having 1.567 reflectivity is defined 100 as the basis of glossiness. Glossiness of Typical Object Sensed by E3X-NL11 + E32-S15

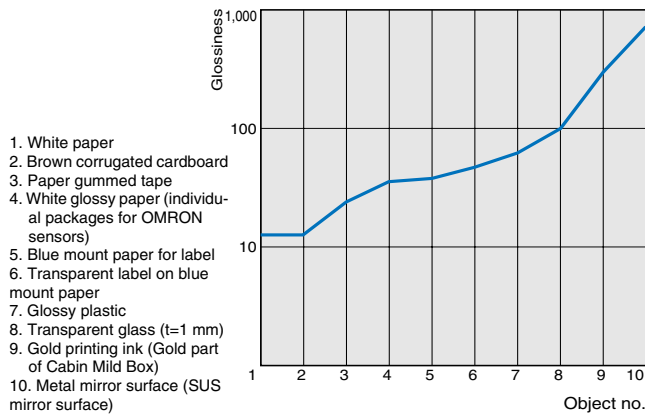

1. White paper
2. Brown corrugated cardboard
3. Paper gummed tape
4. White glossy paper (individual packages for OMRON sensors)
5. Blue mount paper for label
6. Transparent label on blue mount paper
7. Glossy plastic
8. Transparent glass (t=1 mm)
9. Gold printing ink (Gold part of Cabin Mild Box)
10. Metal mirror surface (SUS mirror surface)

Sensing of Transparent Objects with Rotating Fiber Unit Mounting Bracket

There are transparent films and transparent plastic objects that change the direction of polarized light when it passes through the transparent films and transparent plastic objects. When E3X-NL senses these transparent films and transparent plastic objects on glossy background objects, such as glossy paper or metals, E3X-NL will not sense these objects smoothly in case of an incorrect angle of the sensor head. The most suitable angle of the sensor head varies with the transparent object. The angle of the sensor head can be, however, 0° or 45° for the smooth sensing of such transparent objects due to the characteristic of polarized light. There is no need for the angle to be midway between 0° and 45°. E39-L109, which is sold separately, is a mounting bracket that rotates to angles of 0° or 45° and enables E3X-NL to sense such transparent objects smoothly with its sensing head set at 0° or 45° without changing the sensing positive.

(Example) Metal cylindrical object coated with transparent film

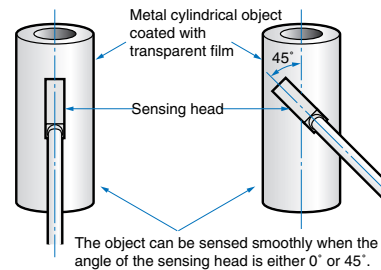

Fuzzy Teaching Function

E3X-NL in two-point teaching operation will perform fuzzy computation using the difference in glossiness and the difference in light energy between the two teaching points to determine the thresholds setting with E3X-NL. As shown in the following table, if there is only a small difference in glossiness but there is a large difference in light energy between the two teaching points, the thresholds set with E3X-NL will be determined by the light energy values.

Taught Difference in glossiness between two teaching points	Taught Difference in light energy between two teaching points	Discriminating method
Large	Large	Discriminated by glossiness.
Large	Small	Discriminated by glossiness.
Small	Large	Discriminated by light energy.
Small	Small	Discriminated by glossiness. A teaching error will result if the difference in glossiness and that in light energy are both less than the sensing levels of E3X-NL.

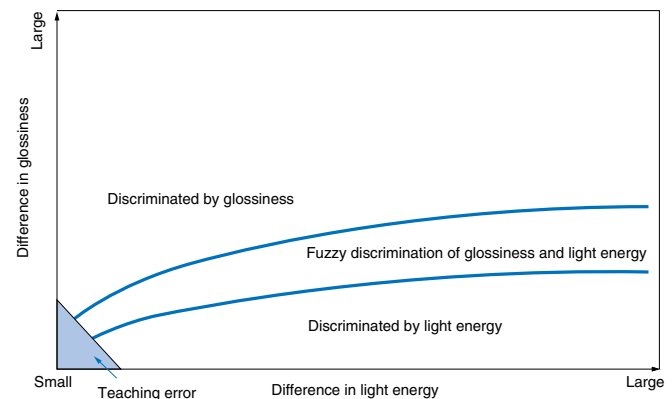

Countermeasures against Teaching Errors Resulted with Transparent Labels on Sheets

The material of the sheets must not be too glossy.

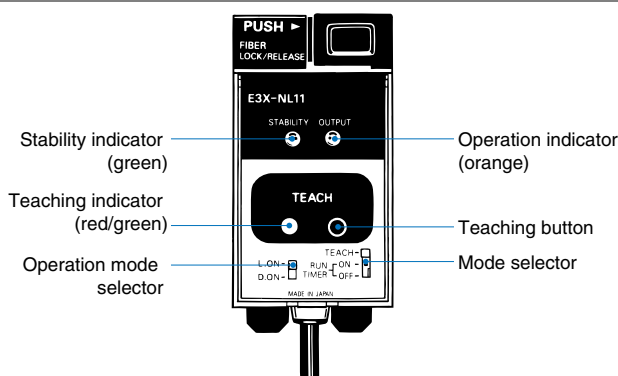

Nomenclature:

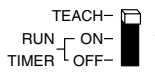
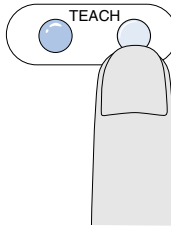
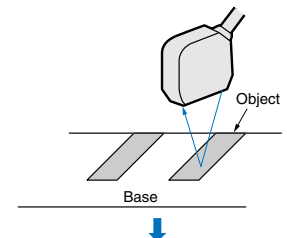
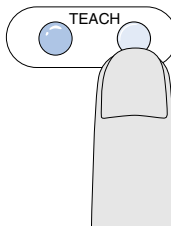
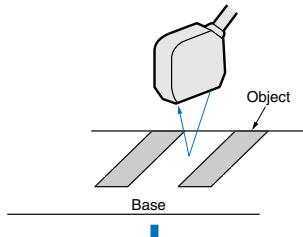
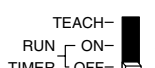
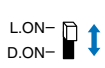

Operation

Sensitivity setting

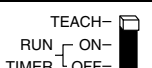
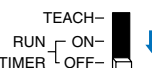
Two-point teaching		
Pro- ce- dur e	Setting	Operation
1	---	Locate the sensor head within the sensing distance.
2		Move the mode selector to the TEACH position.
3		<p>Press the teaching button once with a sensing object located under the sensor as shown in the following illustration.</p>  <p>↓</p> <p>Teaching indicator ... Lit red The built-in buzzer beeps once.</p>
4		<p>With an object absent (ground), press the TEACHING button (second time).</p>  <p>↓</p> <p>If teaching is OK</p> <p>Teaching indicator ... Lit red Lit green The built-in buzzer beeps once.</p> <p>If teaching is NG</p> <p>Teaching indicator ... Lit red Flickers red The built-in buzzer beeps 3 times.</p> <p>↓</p> <p>Change the object position and setting distance again and make setting in order of 1 to 4.</p>
5		<p>Move the mode selector to the RUN position. Sensitivity setting is complete.</p> <p>Teaching indicator ... Lit green Extinguished</p>
6		<p>Light Dark</p> <p>Select the desired operation format with the operation mode selector (L.ON/D.ON).</p>

One-point teaching		
Pro- ce- dur e	Setting	Operation
1		Move the mode selector to the TEACH position.
2		<p>Press the teaching button with one of the sensing objects or the background object located under the sensor for sensing.</p> <p>↓</p> <p>Teaching indicator ... Lit red The built-in buzzer beeps once.</p>
3		<p>Move the mode selector to the RUN position. 1-point teaching setting is complete as soon as the first object passes.</p> <p>Teaching indicator ... Lit red Lit green</p>
4		Select the desired operation format with the operation mode selector (L.ON/D.ON).

Precautions

Correct Use

Fiber Units

Installation

Tightening Force

For the fiber unit installation, tighten it to the torque of 0.3 Nm max.

Fiber Connection and Disconnection

E3X-NL amplifier has a push lock. Connect or disconnect the fibers to or from E3X-NL amplifier using the following procedures:

1. Connection

After inserting the fiber into the Amplifier, push the lock button until a click sound is heard so that the fiber is securely connected.

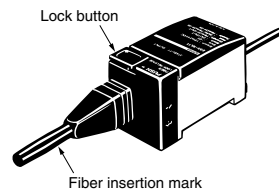

2. Disconnection

Ensure to press the push lock again to unlock before pulling out the fiber, otherwise the fiber may be deteriorated.

(To maintain the fiber characteristics, remove the fiber after making sure that the lock has been released.)

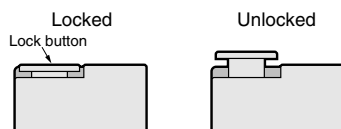

3. The fiber must be locked or released in a temperature range of -10° to 40°.

Since face-to-face installation of the fiber units may cause mutual interference, mount them so that the optical axes of the sensors are not opposed.

Mounting the sensor

If two or more sensors are used, face-to-face installation of the fiber units or the regularly reflected light from the sensing object may cause mutual interference. At this time, adjust the fiber units to be mounted at the angles where the light of each sensor is not received by the fiber unit of the other sensor.

● For adjustment

Two-point Teaching and One-point Teaching

Refer to the following information to select the most suitable sensitivity setting method for the application.

Sensitivity setting method	Two-point teaching	One-point teaching
Difference	In general, use 2-point teaching. The fuzzy teaching function (refer to Technical Guide) is activated to set the optimum algorithms automatically, drawing an operation level just about between the two points taught.	One-point teaching should be performed for the sensing of different objects on a single background object or a single type of objects on a variety of glossy background objects. The operating level will be set 15% above or below the teaching point, depending on the glossiness of the first sensing object. The fuzzy teaching function is not activated for 1-point

Selection of Teaching Point(s)

Two-point Teaching

If E3X-NL is used to sense sensing objects that are only a little different in glossiness from the background object and the sensing objects have color patterns, the difference in glossiness among the inks on the sensing objects may influence the sensing operation of E3X-NL. Therefore perform two-point teaching with E3X-NL at a place where E3X-NL can sense the sensing objects smoothly while considering the characteristics of glossiness versus distance of E3X-NL if the sensing position of each of the sensing objects is different from each other.

One-point Teaching

If E3X-NL is used to sense sensing objects different from each other in glossiness on a single background object, perform one-point teaching with E3X-NL using the background object. If E3X-NL is used to sense identical sensing objects on a variety of glossy background objects, perform one-point teaching with E3X-NL using one of the sensing objects.

Operation Level Setting and Control Output for One-point Teaching

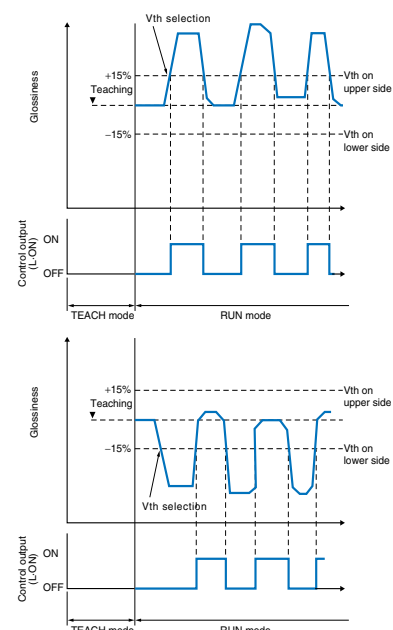

Remote teaching function

In remote teaching, the remote RUN/TEACH input signal is used for teaching instead of the mode selector and the remote teaching input signal is used instead of the teaching button.

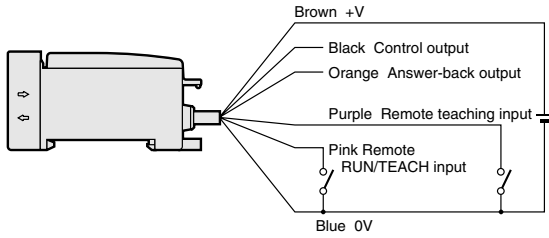
Procedure	Operation
1	Set the mode selector to RUN .
2	<p>The following signal conditions must be given as remote teaching input conditions.</p>  <ol style="list-style-type: none"> ① If there is a teaching error after performing remote two-point teaching with E3X-NL, try performing remote two-point teaching again. If the remote RUN/TEACH input is set from L to H after the teaching error, the thresholds set with E3X-NL will not be refreshed. ② When remote teaching is not performed, cut the pink and purple wires at the root of the cable or connect them to the + side (+V) of the power supply, and cut the orange wire at the root of the cable or connect it to GND (0 V). ③ About 1 s after remote teaching is over, the Sensor is made ready to detect an object.

(Remote 2-point teaching)

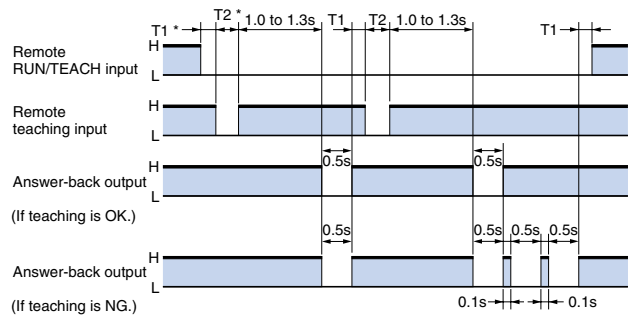

* Note: T1 must be 20 ms minimum and T2 must be 500 ms minimum at the time of remote teaching.

(Remote 1-point teaching)

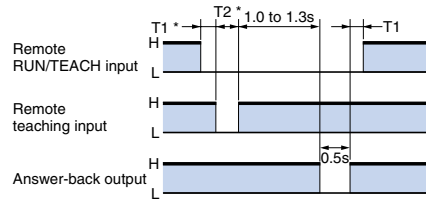

Miscellaneous

EEPROM Write Error

If a write error occurs (buzzer beeps, red and green teaching indicators flicker at the same time, operation and stability indicators flicker) due to power-off, static electricity or other noise in the teaching mode (until the initial operation level compensation completion of teaching without object), perform teaching again with the unit button.

Note: If a memory error occurs, the red and green teaching indicators flicker at the same time and the stability indicator flickers, unlike the teaching error.

Dimensions (Unit: mm)

Sensors

Amplifier Units
E3X-NL11

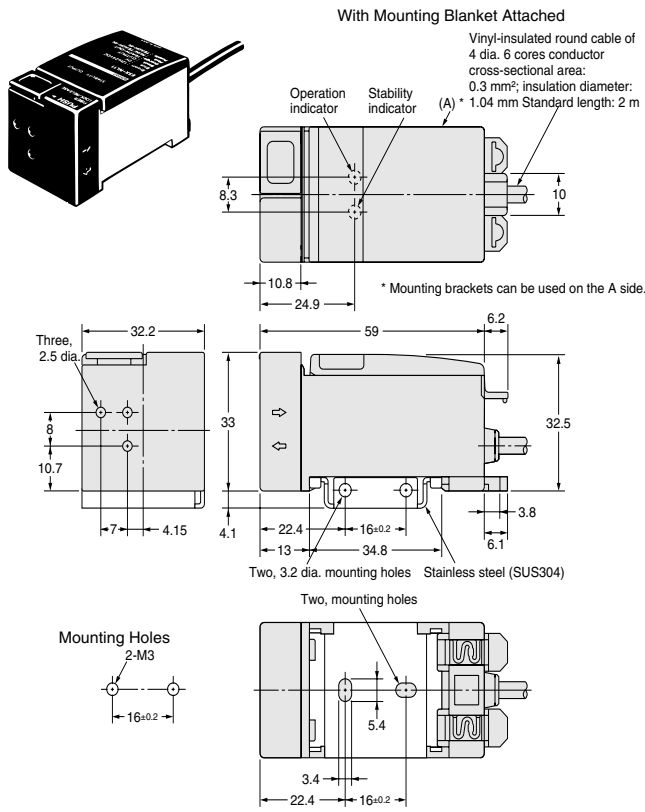

Fiber Units
Short-distance, small spot type
E32-S15-□

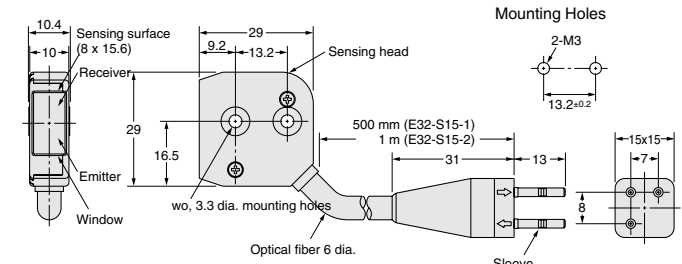

Fiber Units
Long-distance type
E32-S15L-□

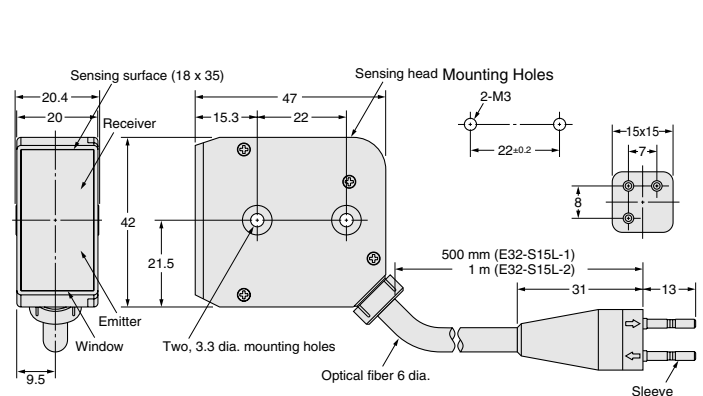

Accessories (Order Separately)

H-5

ALL DIMENSIONS SHOWN ARE IN MILLIMETERS.
To convert millimeters into inches, multiply by 0.03937. To convert grams into ounces, multiply by 0.03527.