





W 2: Sub-Miniature Photoelectric Switch Range: Super-Small and Powerful

	Photoelectric proximity switches BGS
	Photoelectric proximity switches energetic, (V optics)
	Photoelectric reflex switches



	Through-beam photoelectric switches
--	-------------------------------------

The W 2 range offers particular benefits:

- Small housing dimensions allow fitting very close to objects.
- Fast commissioning, easy connection, alignment – ready.
- Laser-like light spot dimensions enable precise detection, e.g. for positioning tasks.
- Even transparent objects or product with reflective surfaces can be detected reliably and accurately.

The following W 2 options are available:

- Photoelectric proximity switches with background suppression and scanning distances of 15 mm and 30 mm.
- Energetic photoelectric proximity switches with “V” optics and scanning distances of 9 mm, 18 mm and 55 mm.
- Energetic photoelectric proximity switches with scanning distances of 34 mm and 115 mm.
- Photoelectric reflex switches with a scanning range of 1.5 m.
- Through-beam photoelectric proximity switches with scanning ranges of 0.5 m and 1.2 m.

Confined spaces in and around machinery – and yet the sensor must meet exacting requirements? The Series W 2 photoelectric switches and photoelectric proximity switches, in two specially developed housing configurations, fit into the smallest spaces and are suitable for virtually any task. Largely insensitive to ambient light and unwanted background reflections, these sensors reliably perform their tasks, even in arduous daily industrial use.

► Fits in almost anywhere.

The WT 2 Flat photoelectric reflex switch is only 3.5 mm thick and reliably detects transparent and reflective objects.

▼ Well adaptable in cramped spaces. Laser-like light spot provides most precise positioning tasks.

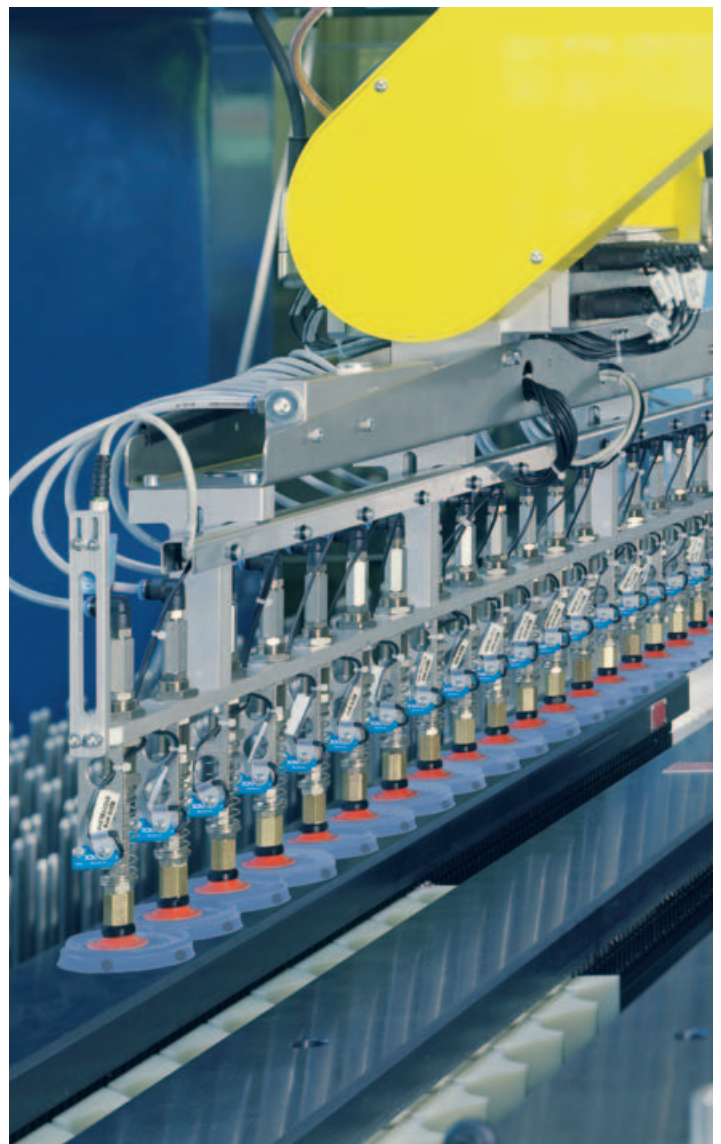
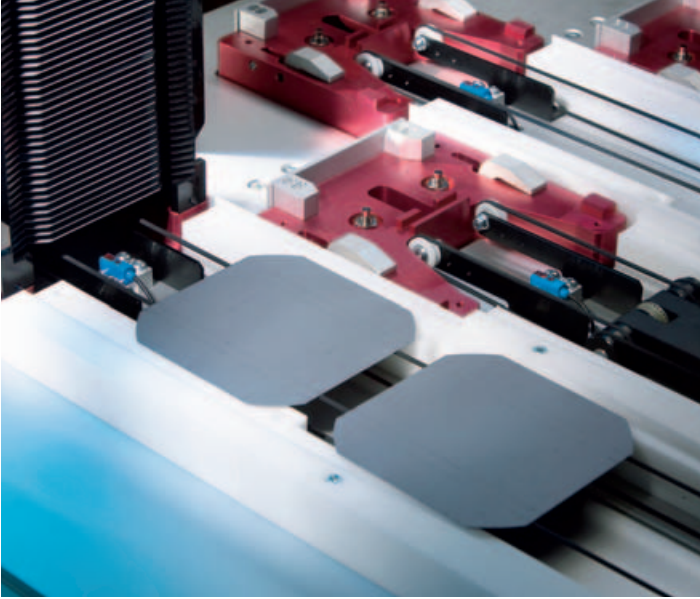

▲ Detection of transparent lids on a gripper arm.

◀ WL 2 Slim photoelectric reflex switch with high scanning range.

Scanning distance
 1 ... 15/30 mm
Photoelectric proximity switch

- A focused, laser-like light spot makes the most precise detection jobs possible
- Insensitive to interference from critical backgrounds
- Sturdy housing with metal sleeves for M3 bolts

Dimensional drawing

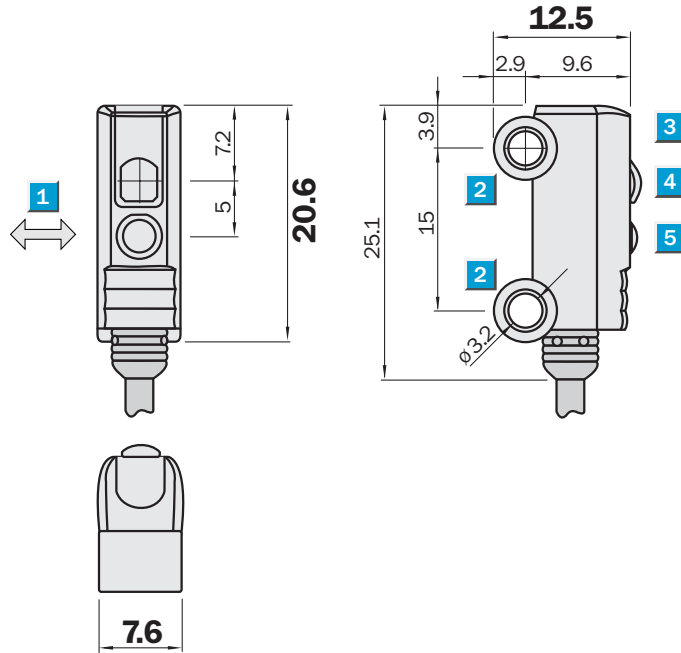

- 1 Standard direction of material being scanned
- 2 Mounting hole \varnothing 3.2 mm
- 3 LED signal strength indicator
- 4 Optical axis, receiver
- 5 Optical axis, sender



Connection type

WT2S-F131	WT2S-F211	WT2S-P411
WT2S-N111	WT2S-P211	WT2S-P431
WT2S-N131	WT2S-P231	
WT2S-P111		
WT2S-P131		

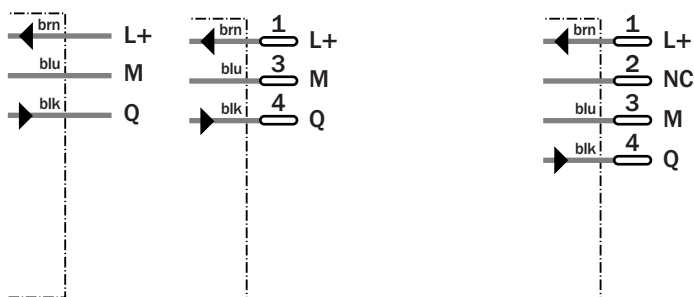
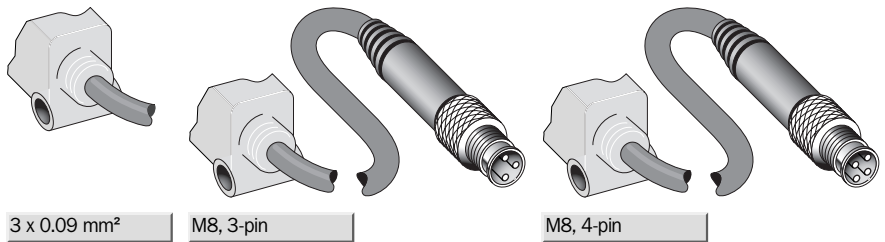

See chapter Accessories
 Connector, M8, 3-pin
 Connector, M8, 4-pin
 Mounting systems

Technical specifications		WT2S-	F131	F211	N111	N131	P111	P131	P211	P231	P411	P431
Scanning distance typ. max.	1 ... 30 mm ¹⁾											
	1 ... 15 mm ¹⁾											
Light source, light type	Pin Point LED, Red light ²⁾											
Light spot diameter	Approx. 1.0 mm at 15 mm distance											
	Approx. 1.2 mm at 8 mm distance											
	Approx. 2.5 mm at 15 mm distance											
Supply voltage V _s	DC 10 ... 30 V ³⁾											
Ripple	< 5 V _{pp} ⁴⁾											
Power consumption	< 20 mA ⁵⁾											
Switching outputs	PNP, Q											
	NPN, Q											
Switching mode	Dark-switching											
	Light-switching											
Output current I _a max	< 50 mA											
Response time	< 0.6 ms ⁶⁾											
Switching frequency	800 Hz ⁷⁾											
Connection type	Cable, PVC, 2 m ⁸⁾											
	Cable with plug, M8, 3-pin, PVC, 200 mm ⁸⁾											
	Cable with plug, M8, 4-pin, PVC, 200 mm ⁸⁾											
VDE protection class	◆											
Circuit protection	V _s connections reverse-polarity protected / Output Q and Q not short-circuit protected / Interference suppression											
Enclosure rating	IP 67, IP 69K											
Ambient temperature operation	-20 °C ... +50 °C											
Ambient temperature storage	-40 °C ... +75 °C											
Weight	18 g											
	20 g											
Housing material	ABS, PMMA											

¹⁾ Object with 90% remission (based on standard white to DIN 5033)

at T_a = +25 °C

³⁾ Limit values

⁴⁾ may not exceed or fall short of

V_s tolerances

⁵⁾ without load

⁶⁾ Signal transit time with resistive load

⁷⁾ with light/dark ratio 1:1

⁸⁾ do not bend below 0 °C

Scanning distance and light spot diameter

Scanning distance 1 ... 30 mm

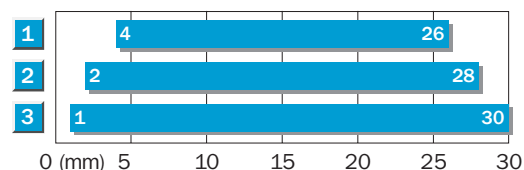

- 1 Scanning distance on black, 6 % remission
- 2 Scanning distance on grey, 18 % remission
- 3 Scanning distance on white, 90 % remission

Scanning distance 1 ... 15 mm

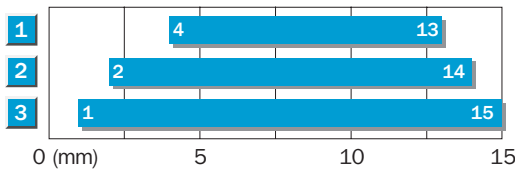

- 1 Scanning distance on black, 6 % remission
- 2 Scanning distance on grey, 18 % remission
- 3 Scanning distance on white, 90 % remission

Light spot diameter at SD 1 ... 30 mm

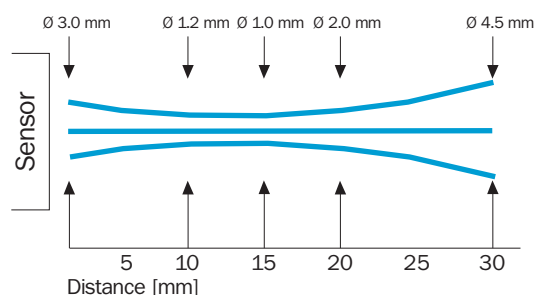

Light spot diameter at SD 1 ... 15 mm

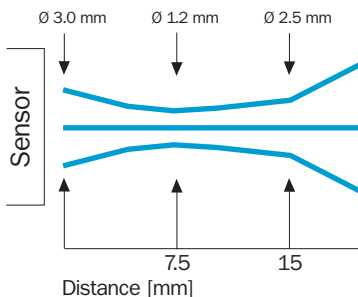

Ordering information

Type	Order no.
WT2S-F131	1 025 682
WT2S-F211	1 024 171
WT2S-N111	1 022 662
WT2S-N131	1 022 663
WT2S-P111	1 022 660
WT2S-P131	1 022 661
WT2S-P211	1 022 658
WT2S-P231	1 022 659
WT2S-P411	1 023 631
WT2S-P431	1 023 632

Scanning distance
1 ... 55 mm

Photoelectric proximity switch

- Precise, small light spot
- Extremely good size/performance ratio
- Sturdy housing with metal sleeves for M3 bolts

Dimensional drawing

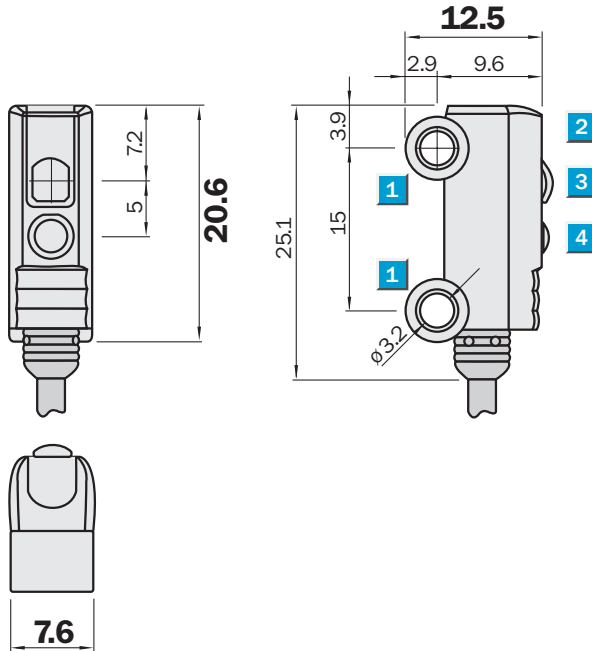

- 1 Mounting hole Ø 3.2 mm
- 2 LED signal strength indicator
- 3 Optical axis, receiver
- 4 Optical axis, sender



Connection type

WT2S-N161	WT2S-P261	WT2S-P461
WT2S-P161		

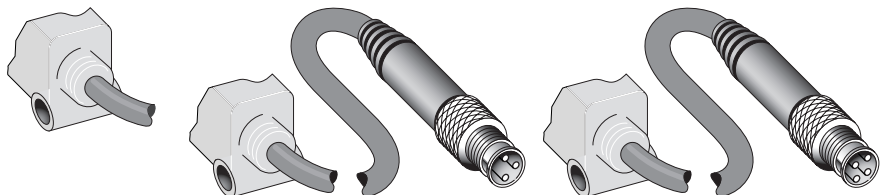

3 x 0.09 mm²

M8, 3-pin

M8, 4-pin

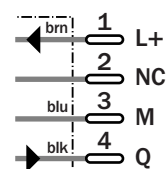
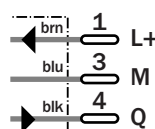
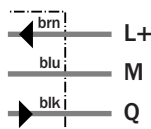

See chapter Accessories

- Connector, M8, 3-pin
- Connector, M8, 4-pin
- Mounting systems

Technical specifications		WT2S-	N161	P161	P261	P461						
Scanning distance typ. max.	1 ... 55 mm ¹⁾											
Light source, light type	Pin Point LED, Red light ²⁾											
Light spot diameter	Approx. 3.5 mm at 50 mm distance											
Supply voltage V _s	DC 10 ... 30 V ³⁾											
Ripple	< 5 V _{pp} ⁴⁾											
Power consumption	< 20 mA ⁵⁾											
Switching outputs	NPN, Q											
	PNP, Q											
Switching mode	Light-switching											
Output current I _a max	< 50 mA											
Response time	< 0.6 ms ⁶⁾											
Switching frequency	800 Hz ⁷⁾											
Connection type	Cable, PVC, 2 m ⁸⁾											
	Cable with plug, M8, 3-pin, PVC, 200 mm ⁸⁾											
	Cable with plug, M8, 4-pin, PVC, 200 mm ⁸⁾											
VDE protection class	⊖											
Circuit protection	V _s connections reverse-polarity protected / Output Q and Q not short-circuit protected / Interference suppression											
Enclosure rating	IP 67, IP 69K											
Ambient temperature operation	-20 °C ... +50 °C											
Ambient temperature storage	-40 °C ... +75 °C											
Weight	18 g											
	20 g											
Housing material	ABS, PMMA											

¹⁾ Object with 90% remission (based on standard white to DIN 5033)
²⁾ Average service life 75,000 h

at T_a = +25 °C
³⁾ Limit values
⁴⁾ may not exceed or fall short of

V_s tolerances
⁵⁾ without load
⁶⁾ Signal transit time with resistive load

⁷⁾ with light/dark ratio 1:1
⁸⁾ do not bend below 0 °C

Scanning distance and light spot diameter

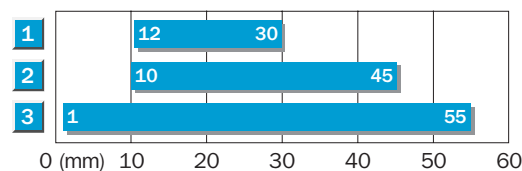

- 1 Scanning distance on black, 6 % remission
- 2 Scanning distance on grey, 18 % remission
- 3 Scanning distance on white, 90 % remission

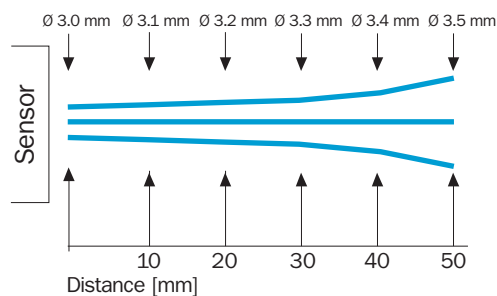

Ordering information

Type	Order no.
WT2S-N161	1 022 665
WT2S-P161	1 022 664
WT2S-P261	1 023 640
WT2S-P461	1 023 641

Scanning distance
1/2 ... 9/18 mm

Photoelectric proximity switch

- Detection of transparent and reflective objects
- Robust housing with metal-reinforced fixing holes
- Simple adjustment. Connect, align - ready
- No external amplifier required. Can be directly connected to the machine control system

Dimensional drawing

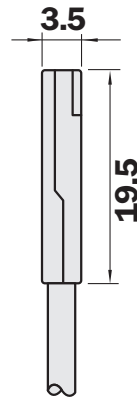
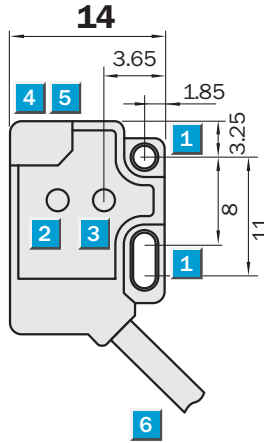

- 1 Mounting hole \varnothing 2.1 mm
- 2 Optical axis, sender
- 3 Optical axis, receiver
- 4 LED indicator orange; output active
- 5 LED indicator green; strength indicator
- 6 Connection



Connection type

WT2F-N140
WT2F-N170
WT2F-P140
WT2F-P170

WT2F-P240
WT2F-P270

WT2F-P440
WT2F-P470

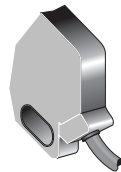

3 x 0.09 mm²

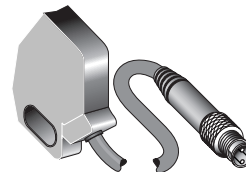
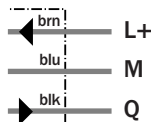

M8, 3-pin

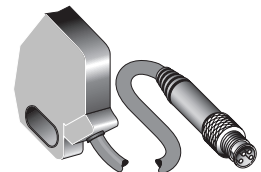
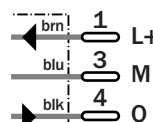

M8, 4-pin

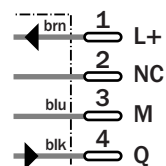

See chapter Accessories

- Connector, M8, 3-pin
- Connector, M8, 4-pin

Technical specifications		WT2F-	N140	N170	P140	P170	P240	P270	P440	P470
Scanning distance typ. max.	2 ... 18 mm ¹⁾									
	1 ... 9 mm ¹⁾									
Operating distance	2 ... 15 mm ¹⁾									
	1 ... 8 mm ¹⁾									
Light source, light type	LED, Red light, 660 nm ²⁾									
Supply voltage V_s	DC 12 ... 24 V ³⁾									
Ripple	≤ 5 V _{pp} ⁴⁾									
Power consumption	≤ 20 mA ⁵⁾									
Switching outputs	NPN: open collector: Q									
	PNP: open collector: Q									
Switching mode	Light-switching									
Signal voltage PNP HIGH / LOW	V _s - 1.8 V / approx. 0 V									
Signal voltage NPN HIGH / LOW	Approx. V _s / < 1.8 V									
Output current I _a max	≤ 50 mA									
Response time	≤ 0.5 ms ⁶⁾									
Switching frequency	1,000 Hz ⁷⁾									
Connection type	Cable, PVC, 2 m ⁸⁾									
	Cable with plug, M8, 3-pin, PVC, 200 mm ⁸⁾									
	Cable with plug, M8, 4-pin, PVC, 200 mm ⁸⁾									
VDE protection class	◆									
Circuit protection	V _s connections reverse-polarity protected / In-/outputs short-circuit protected / Outputs overcurrent and short-circuit protected									
Enclosure rating	IP 67									
Ambient temperature operation	-20 °C ... +50 °C									
Ambient temperature storage	-40 °C ... +75 °C									
Weight	Approx. 20 g									
Housing material	PC / PBT, PC									

¹⁾ Object with 90% remission (based on standard white to DIN 5033)

²⁾ Average service life 100,000 h

at T_a = +25 °C

³⁾ ± 10%

⁴⁾ may not exceed or fall short of

V_s tolerances

⁵⁾ without load

⁶⁾ Signal transit time with resistive load

⁷⁾ with light/dark ratio 1:1

⁸⁾ do not bend below 0 °C

Scanning distance and function reserve

Scanning distance 2 ... 18 mm

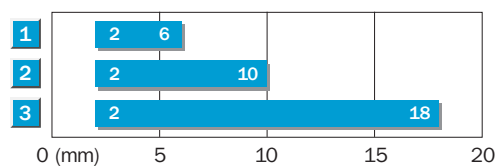

- 1 Scanning distance on black, 6 % remission
- 2 Scanning distance on grey, 18 % remission
- 3 Scanning distance on white, 90 % remission

Scanning distance 1 ... 9 mm

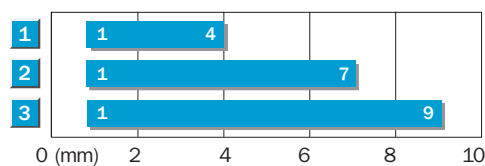

- 1 Scanning distance on black, 6 % remission
- 2 Scanning distance on grey, 18 % remission
- 3 Scanning distance on white, 90 % remission

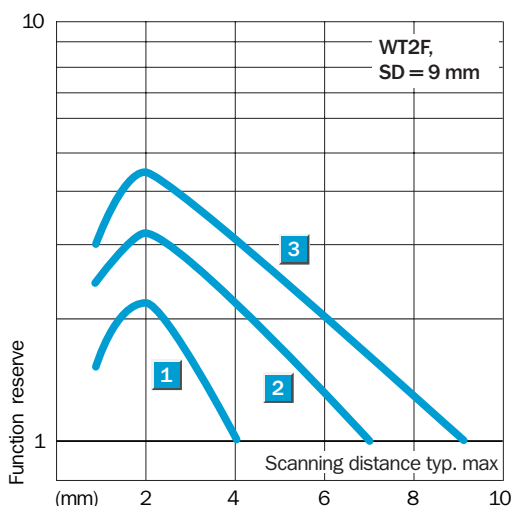
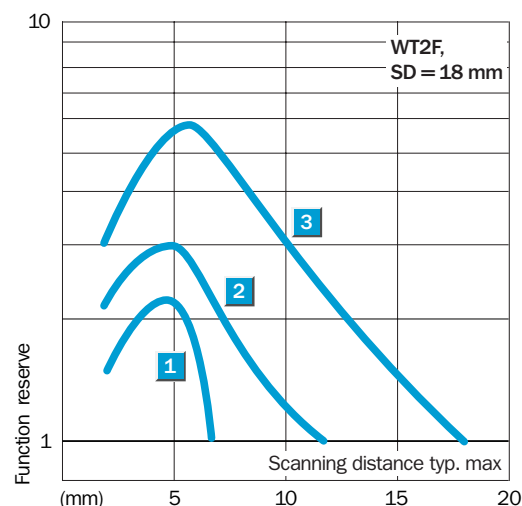

Ordering information

Type	Order no.
WT2F-N140	6 030 583
WT2F-N170	6 030 587
WT2F-P140	6 030 584
WT2F-P170	6 030 588
WT2F-P240	6 030 585
WT2F-P270	6 030 589
WT2F-P440	6 030 586
WT2F-P470	6 030 590

Scanning distance
2/4 ... 34/115 mm

Photoelectric proximity switch

- Robust housing with metal-reinforced fixing holes
- Simple adjustment.
Connect, align - ready
- No external amplifier required.
Can be directly connected to the machine control system

Dimensional drawing

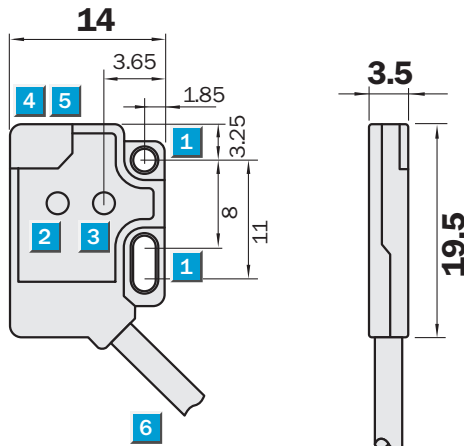

- 1 Mounting hole \varnothing 2.1 mm
- 2 Optical axis, sender
- 3 Optical axis, receiver
- 4 LED indicator orange; output active
- 5 LED indicator green; strength indicator
- 6 Connection



See chapter Accessories

Connector, M8, 3-pin

Connector, M8, 4-pin

Connection type

WT2F-N150
WT2F-N180
WT2F-P150
WT2F-P180

WT2F-P250
WT2F-P280

WT2F-P450
WT2F-P480

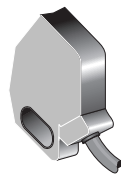

3 x 0.09 mm²

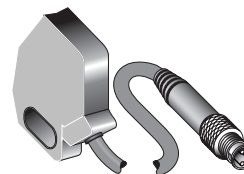

M8, 3-pin

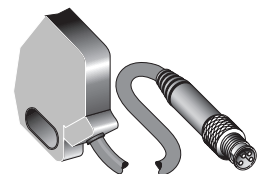
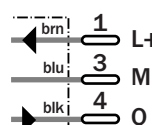

M8, 4-pin

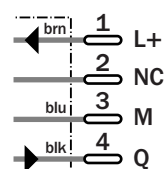

Technical specifications		WT2F-	N150	N180	P150	P180	P250	P280	P450	P480
Scanning distance typ. max.	2 ... 34 mm ¹⁾									
	4 ... 115 mm ¹⁾									
Operating distance	2 ... 30 mm ¹⁾									
	4 ... 100 mm ¹⁾									
Light source, light type	LED, Red light, 660 nm ²⁾									
Supply voltage V_s	DC 12 ... 24 V ³⁾									
Ripple	≤ 5 V _{pp} ⁴⁾									
Power consumption	≤ 20 mA ⁵⁾									
Switching outputs	NPN: open collector: Q									
	PNP: open collector: Q									
Switching mode	Light-switching									
Signal voltage PNP HIGH / LOW	V _s - 1.8 V / approx. 0 V									
Signal voltage NPN HIGH / LOW	Approx. V _s / < 1.8 V									
Output current I _a max	≤ 50 mA									
Response time	≤ 0.5 ms ⁶⁾									
Switching frequency	1,000 Hz ⁷⁾									
Connection type	Cable, PVC, 2 m ⁸⁾									
	Cable with plug, M8, 3-pin, PVC, 200 mm ⁸⁾									
	Cable with plug, M8, 4-pin, PVC, 200 mm ⁸⁾									
VDE protection class	◆									
Circuit protection	V _s connections reverse-polarity protected / In-/outputs short-circuit protected / Outputs overcurrent and short-circuit protected									
Enclosure rating	IP 67									
Ambient temperature operation	-20 °C ... +50 °C									
Ambient temperature storage	-40 °C ... +75 °C									
Weight	Approx. 20 g									
Housing material	PC / PBT, PC									

¹⁾ Object with 90% remission (based on standard white to DIN 5033)
²⁾ Average service life 100,000 h

at T_a = +25°C
³⁾ ± 10%
⁴⁾ may not exceed or fall short of

V_s tolerances
⁵⁾ without load
⁶⁾ Signal transit time with resistive load

⁷⁾ with light/dark ratio 1:1
⁸⁾ do not bend below 0 °C

Scanning distance and function reserve

Scanning distance 4 ... 115 mm

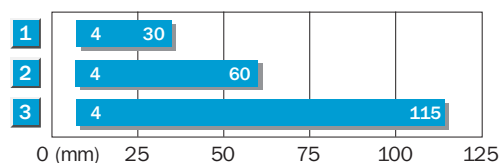

- 1 Scanning distance on black, 6 % remission
- 2 Scanning distance on grey, 18 % remission
- 3 Scanning distance on white, 90 % remission

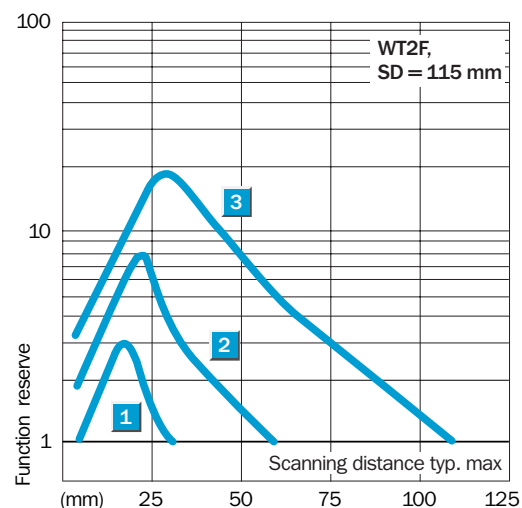

Scanning distance 2 ... 34 mm

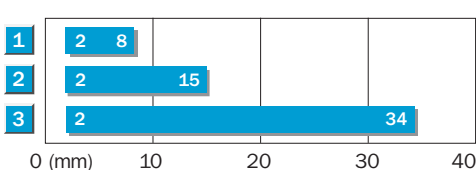

- 1 Scanning distance on black, 6 % remission
- 2 Scanning distance on grey, 18 % remission
- 3 Scanning distance on white, 90 % remission

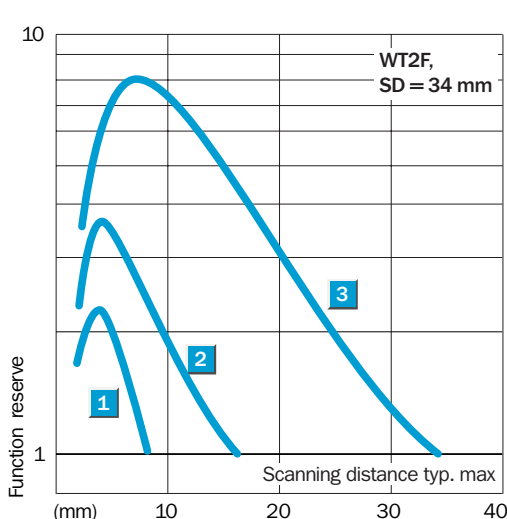

Ordering information

Type	Order no.
WT2F-N150	6 030 576
WT2F-N180	6 030 572
WT2F-P150	6 030 580
WT2F-P180	6 030 573
WT2F-P250	6 030 581
WT2F-P280	6 030 574
WT2F-P450	6 030 582
WT2F-P480	6 030 575

Photoelectric reflex switch, WL 2 Slim, red light

Scanning range
0.04 ... 0.8 m

Photoelectric reflex switch

- Extremely good size /performance ratio
- Easy and fast alignment using ball joint bracket
- Sturdy housing with metal sleeves for M3 bolts

Dimensional drawing

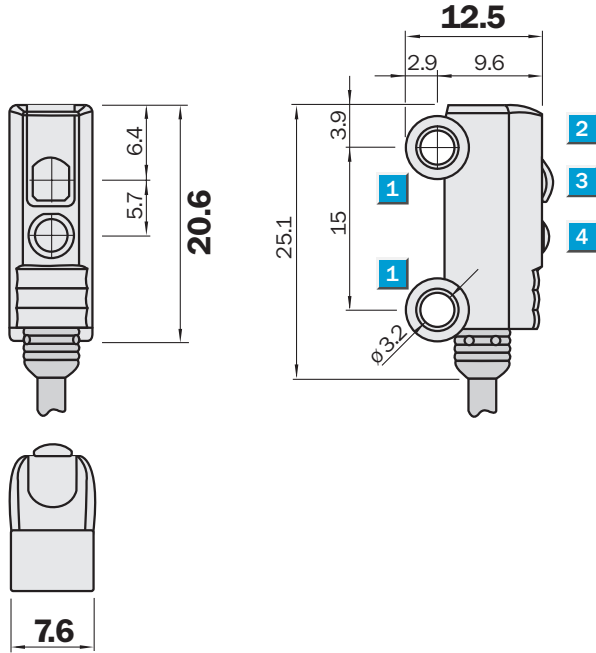

- 1 Mounting hole \varnothing 3.2 mm
- 2 LED signal strength indicator
- 3 Optical axis, receiver
- 4 Optical axis, sender



Connection type

WL2S-E111	WL2S-F211	WL2S-F411
WL2S-F111	WL2S-P211	
WL2S-N111		
WL2S-P111		

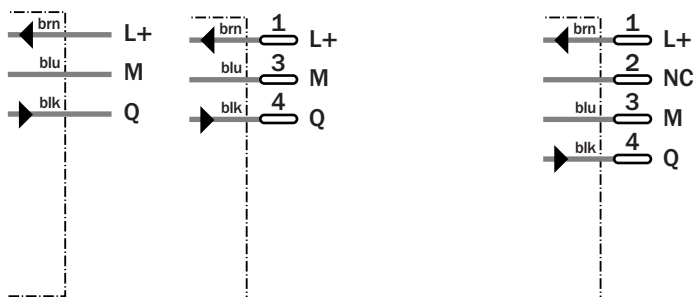
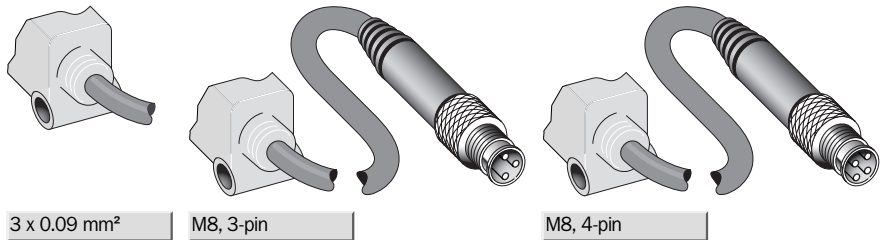

See chapter Accessories

- Connector, M8, 3-pin
- Connector, M8, 4-pin
- Mounting systems
- Reflectors

Technical specifications		WL2S-	E111	F111	F211	F411	N111	P111	P211			
Scanning range typ. max.	0.04 ... 0.8 m											
Scanning range, recommended	0.04 ... 0.4 m											
Relating to	Reflector PL 20 A											
Light source, light type	Pin Point LED, Red light ¹⁾											
Light spot diameter	10 mm at 100 mm distance											
Supply voltage V_s	DC 10 ... 30 V ²⁾											
Ripple	< 5 V _{pp} ³⁾											
Power consumption	< 20 mA ⁴⁾											
Switching outputs	NPN, Q											
	PNP, Q											
Switching mode	Dark-switching											
	Light-switching											
Output current I_a max	< 50 mA											
Response time	< 0.6 ms ⁵⁾											
Switching frequency	800 Hz ⁶⁾											
Connection type	Cable, PVC, 2 m ⁷⁾											
	Cable with plug, M8, 3-pin, PVC, 200 mm ⁷⁾											
	Cable with plug, M8, 4-pin, PVC, 2 m ⁷⁾											
VDE protection class	◆											
Circuit protection	V_s connections reverse-polarity protected / Output Q and Q not short-circuit protected / Interference suppression											
Enclosure rating	IP 67, IP69K											
Ambient temperature operation	-20 °C ... +50 °C											
Ambient temperature storage	-40 °C ... +75 °C											
Weight	18 g											
	20 g											
Housing material	ABS, PMMA											

¹⁾ Average service life 75,000 h at $T_a = +25^\circ\text{C}$
²⁾ Limit values of V_s tolerances
³⁾ may not exceed or fall short
⁴⁾ without load
⁵⁾ Signal transit time with resistive load
⁶⁾ with light/dark ratio 1:1
⁷⁾ do not bend below 0 °C

Scanning range and function reserve

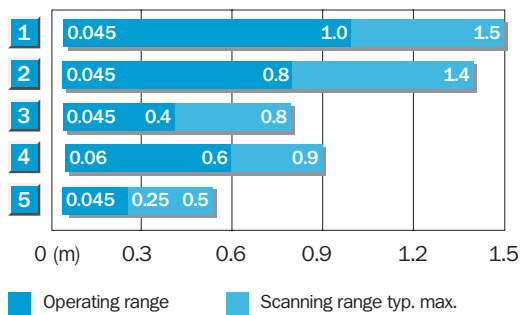

Reflector Type	Operating range
1 PL 40 A	0.045 ... 1.0 m
2 PL 30 A	0.045 ... 0.8 m
3 PL 20 A	0.045 ... 0.4 m
4 PL 22	0.06 ... 0.6 m
5 PL 10 F *)	0.045 ... 0.25 m

*) With reflector arrangement along the sensor axis

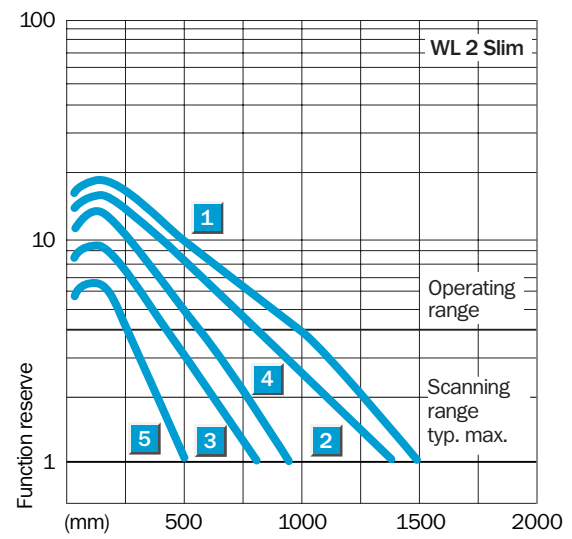

Ordering information	
Type	Order no.
WL2S-E111	1 022 667
WL2S-F111	1 022 666
WL2S-F211	1 023 868
WL2S-F411	1 023 644
WL2S-N111	1 023 870
WL2S-P111	1 023 869
WL2S-P211	1 024 249

Through-beam photoelectric switch, WS/WE 2 Slim, red light



Scanning range
0 ... 1.2 m

Through-beam photoelectric

- Excellent size/performance ratio
- Sturdy housing with metal sleeves for M3 bolts

Dimensional drawing

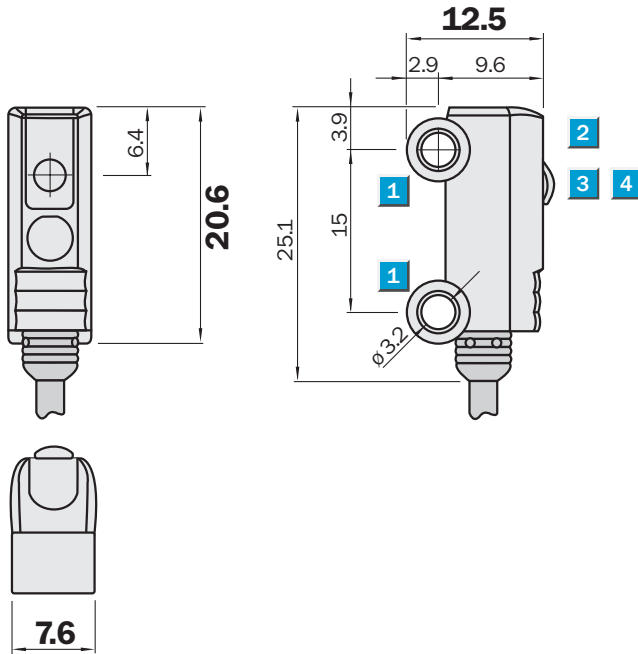

- 1 Mounting hole $\varnothing 3.2$ mm
- 2 LED signal strength indicator
- 3 Optical axis, receiver
- 4 Optical axis, sender

Connection type

WS/WE2S-E113

WS/WE2S-F113

WS/WE2S-F213

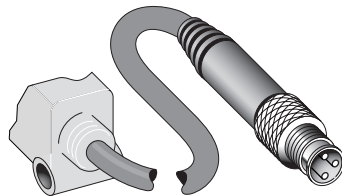
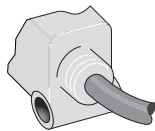

Sender 2 x 0.09 mm²

M8, 3-pin

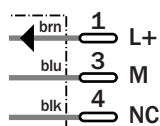
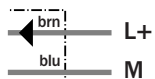

Receiver 3 x 0.09 mm²

M8, 3-pin

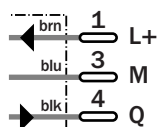
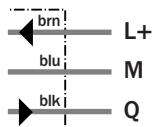

See chapter Accessories

Connector, M8, 3-pin

Mounting systems

Technical specifications		WS/WE2S-	E113	F113	F213							
Scanning range typ. max.	0 ... 1.2 m											
Scanning range, recommended	0 ... 1 m											
Light source, light type	Pin Point LED, Red light ¹⁾											
Light spot diameter	10 mm at 100 mm distance											
Supply voltage V_s	DC 10 ... 30 V ²⁾											
Ripple	< 5 V _{pp} ³⁾											
Power consumption, sender	< 20 mA ⁴⁾											
Power consumption, receiver	< 10 mA ⁴⁾											
Switching outputs	NPN, Q											
	PNP, Q											
Switching mode	Dark-switching											
Output current I_a max	< 50 mA											
Response time	< 2.5 ms ⁵⁾											
Switching frequency	200 Hz ⁶⁾											
Connection type	Cable, PVC, 2 m ⁷⁾											
	Cable with plug, M8, 3-pin, PVC, 200 mm ⁷⁾											
VDE protection class	◆											
Circuit protection	V_s connections reverse-polarity protected / Output Q and Q not short-circuit protected / Interference suppression											
Enclosure rating	IP 67, IP69K											
Ambient temperature operation	-20 °C ... +50 °C											
Ambient temperature storage	-40 °C ... +75 °C											
Weight	36 g											
	40 g											
Housing material	ABS, PMMA											

¹⁾ Average service life 75,000 h at $T_a = +25^\circ\text{C}$

²⁾ Limit values

³⁾ may not exceed or fall short of

V_s tolerances
⁴⁾ without load

⁵⁾ Signal transit time with resistive load

⁶⁾ with light/dark ratio 1:1

⁷⁾ do not bend below 0 °C

Scanning distance and function reserve

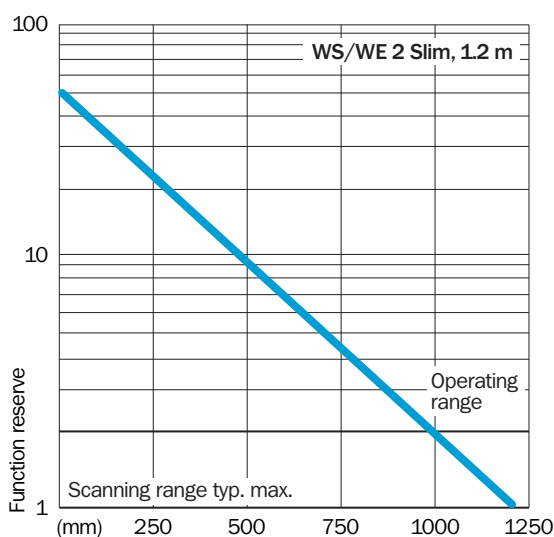
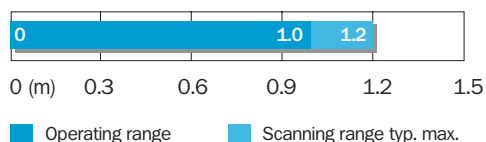

Ordering information

Type	Order no.
WS/WE2S-E113	1 022 669
WS/WE2S-F113	1 022 668
WS/WE2S-F213	1 023 650

Through-beam photoelectric switch, WS/WE 2 Flat, red light



Scanning range
0 ... 0.5 m

Through-beam photoelectric

- Robust housing with metal-reinforced fixing holes
- Simple adjustment.
Connect, align - ready
- No external amplifier required.
Can be directly connected to the machine control system

Dimensional drawing

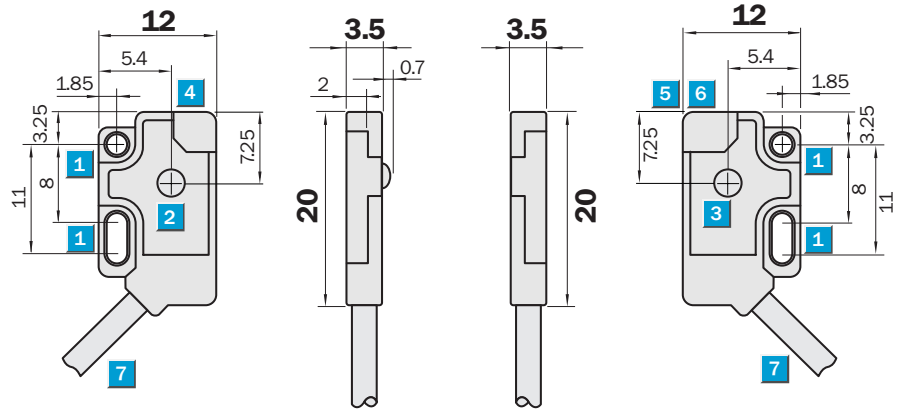

- 1 Mounting hole \varnothing 2.1 mm
- 2 Optical axis, sender
- 3 Optical axis, receiver
- 4 LED indicator green; supply voltage
- 5 LED indicator orange; output active
- 6 LED indicator green; strength indicator
- 7 Connection



Connection type

WS/WE2F-E110
WS/WE2F-F110
WS/WE2F-N110

WS/WE2F-F210
WS/WE2F-P210

WS/WE2F-F410

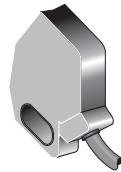

Sender 2 x 0.09 mm²

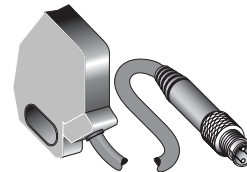
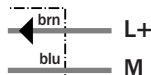

M8, 3-pin

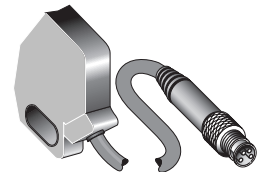
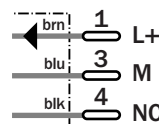

M8, 4-pin

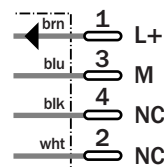

See chapter Accessories

- Connector, M8, 3-pin
- Connector, M8, 4-pin

Receiver 3 x 0.09 mm²

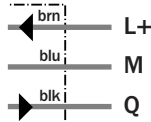

M8, 3-pin

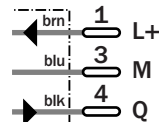

M8, 4-pin

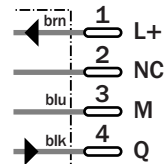

Technical specifications		WS/WE2F-	E110	F110	F210	F410	N110	P210				
Scanning range typ. max.	0 ... 0.5 m											
Scanning range, recommended	0 ... 0.4 m											
Light source, light type	LED, Red light, 660 nm ¹⁾											
Supply voltage V _s	DC 12 ... 24 V ²⁾											
Ripple	≤ 5 V _{pp} ³⁾											
Power consumption, sender	≤ 10 mA											
Power consumption, receiver	≤ 15 mA ⁴⁾											
Switching outputs	NPN: open collector: Q											
	PNP: open collector: Q											
Switching mode	Dark-switching											
	Light-switching											
Signal voltage PNP HIGH / LOW	V _s - 1.8 V / approx. 0 V											
Signal voltage NPN HIGH / LOW	Approx. V _s / < 1.8 V											
Output current I _a max	≤ 50 mA											
Response time	≤ 0.5 ms ⁵⁾											
Switching frequency	1,000 Hz ⁶⁾											
Connection type	Cable, PVC, 2 m ⁷⁾											
	Cable with plug, M8, 3-pin, PVC, 200 mm ⁷⁾											
	Cable with plug, M8, 4-pin, PVC, 200 mm ⁷⁾											
VDE protection class	⊠											
Circuit protection	V _s connections reverse-polarity protected / In-/outputs short-circuit protected / Outputs overcurrent and short-circuit protected											
Enclosure rating	IP 67											
Ambient temperature operation	-20 °C ... +50 °C											
Ambient temperature storage	-40 °C ... +75 °C											
Weight	Approx. 35 g											
	Approx. 20 g											
Housing material	PC / PBT, PC											

¹⁾ Average service life 100,000 h at T_a = +25 °C
²⁾ ± 10%
³⁾ may not exceed or fall short of
⁴⁾ V_s tolerances without load
⁵⁾ Signal transit time with resistive load
⁶⁾ with light/dark ratio 1:1
⁷⁾ do not bend below 0 °C

Scanning distance and function reserve

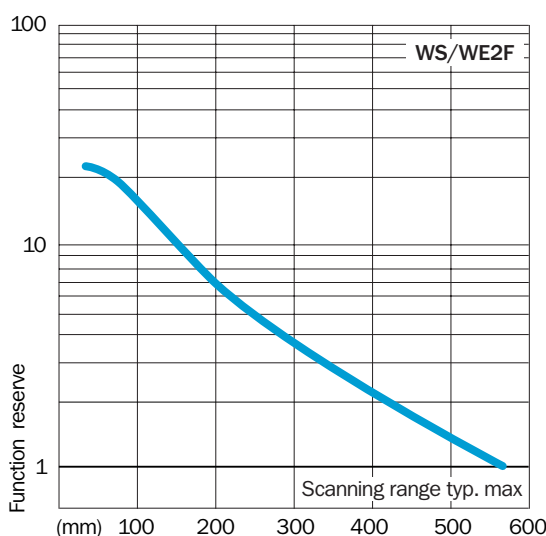
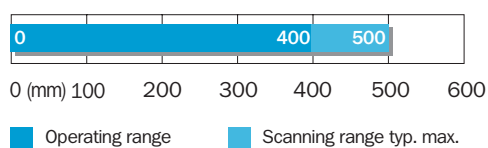

Ordering information	
Type	Order no.
WS/WE2F-E110	6 030 554
WS/WE2F-F110	6 030 569
WS/WE2F-F210	6 030 570
WS/WE2F-F410	6 030 571
WS/WE2F-N110	6 030 540
WS/WE2F-P210	6 030 566

W4-3: Miniature Photoelectric Switch Family: Efficient and Space-Saving

	Photoelectric proximity switches BGS
	Photoelectric reflex switches
	Through-beam photoelectric switches



ground suppression. In conjunction with the robust housing, the W4-3 sensors remain largely unaffected by the influence of environmental effects! Whether humidity or water spray, EMC contamination, flashlights or heavy vibrations, the miniature sensors operate reliably in harsh industrial environments.

Unsurpassed ease of use with the new process of electronic active background suppression. Fast commissioning at the touch of a button or, if the sensor is inaccessible, via control cable. Secure setting via potentiometer.

The outer dimensions of a sugar cube and, inside, the technology of a large photoelectric switch.

The integration of photoelectric proximity switches no longer depends on space, even for demanding tasks.

Reliable detection of small, transparent or even reflective objects is standard, as is reliable detection largely irrespective of colour and surface finish.

The W4-3 series sensors reliably detect objects with low reflectance even where a moving background is only a few millimetres away - the result of a new chip-set specifically developed for this task, enabling precise active back-

So, the sensor is built for the future. The specially developed chip-set is field bus enabled. Remote maintenance, parametrisation and diagnostics can be implemented.

The W4-3 series photoelectric reflex switch offers important customer benefits:

- Secure and fast alignment through an easily visible, intensive red homogeneous light spot.
- Minimum assembly through optimum housing shape, requiring no mounting bracket for most installations.

▼ The WL4-3 photoelectric reflex switch with high visibility light spot. Fast and easy alignment. Good recognition of transparent objects.

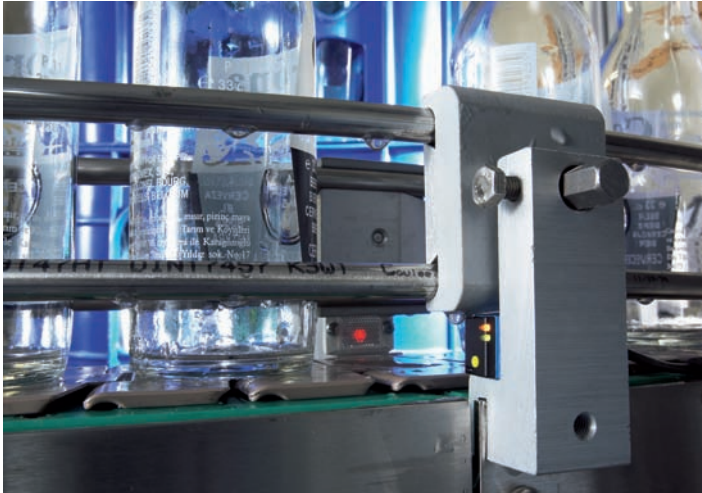

▼ WT4-3 photoelectric proximity switch with 'V' optics for the reliable detection of reflective and transparent objects.

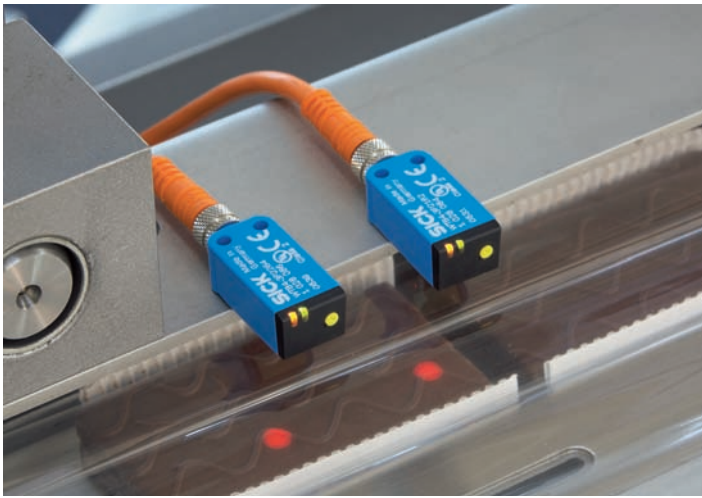
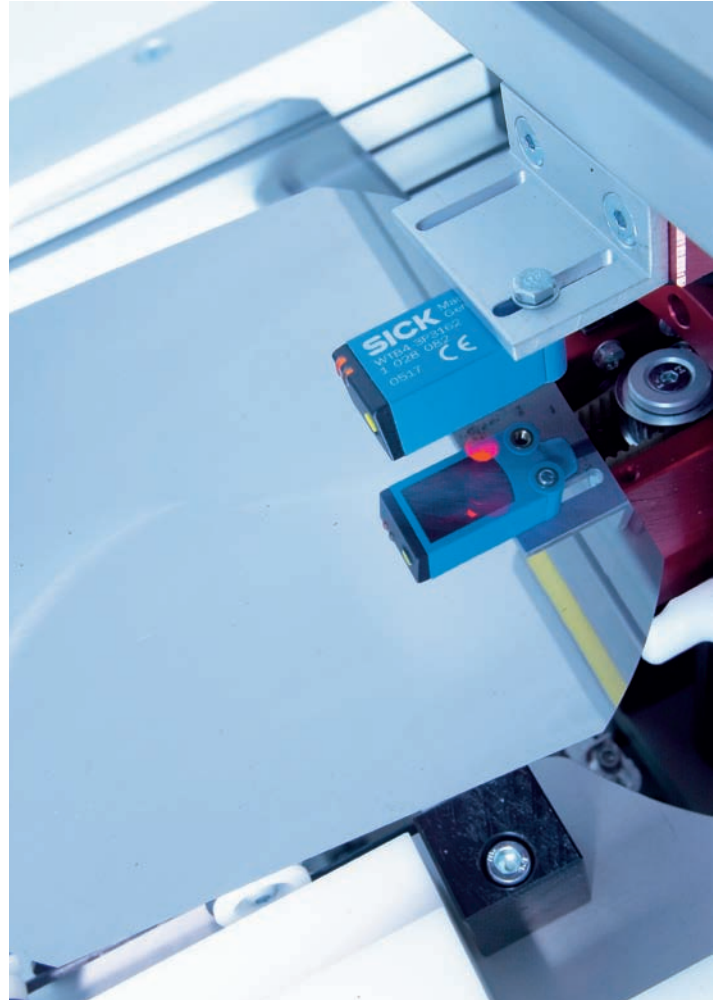

▲ Detection of dark black objects with the WT4-3 photoelectric proximity switch.

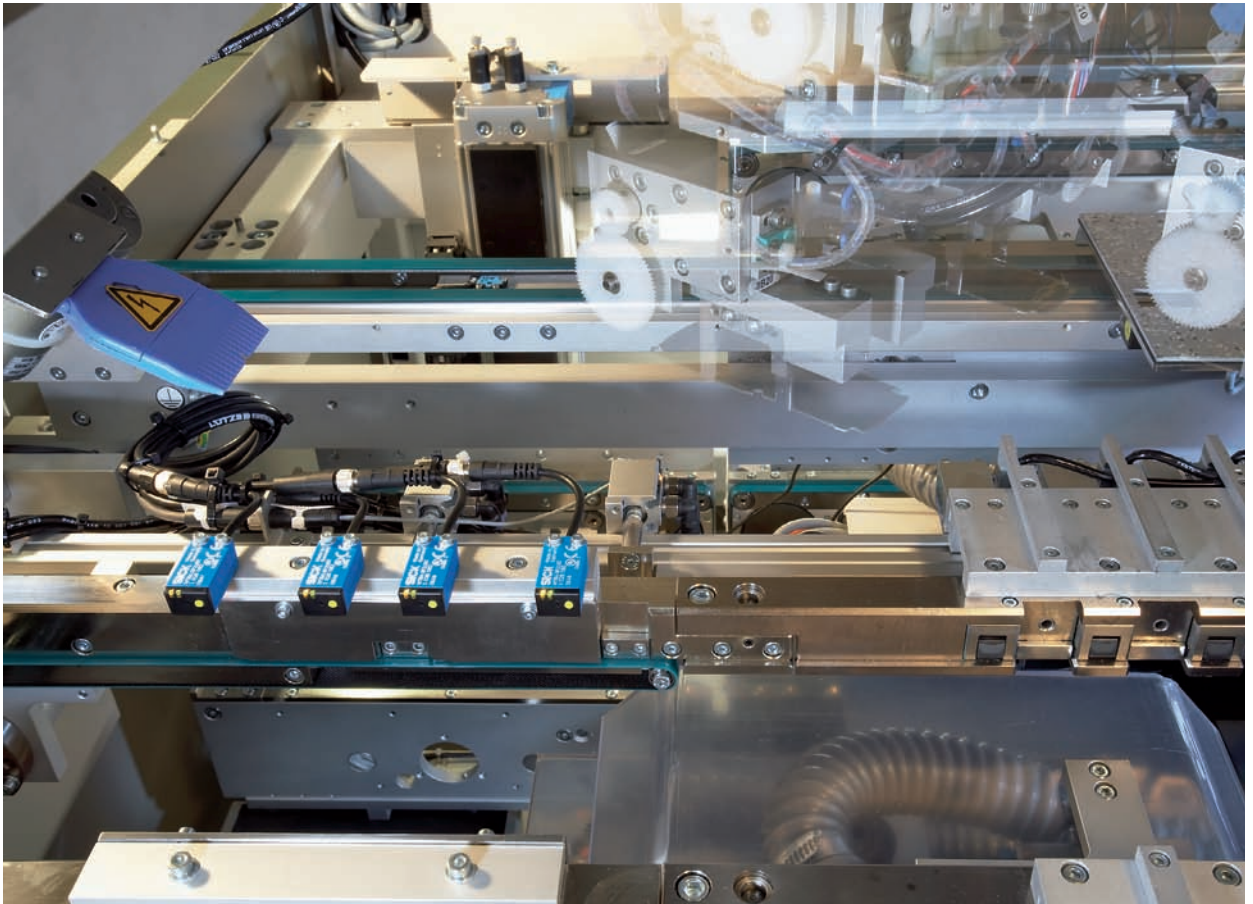

► Optimum and safe use. No mutual interference, reliable suppression of reflective, moving backgrounds with the WT4-3 photoelectric proximity switch.

Scanning distance
4 ... 150 mm

Photoelectric proximity switch

- Commissioning by simple Teach-in function
- Object detection almost irrespective of colour and background consistency
- Secure function when mounted opposite other sensors

Dimensional drawing

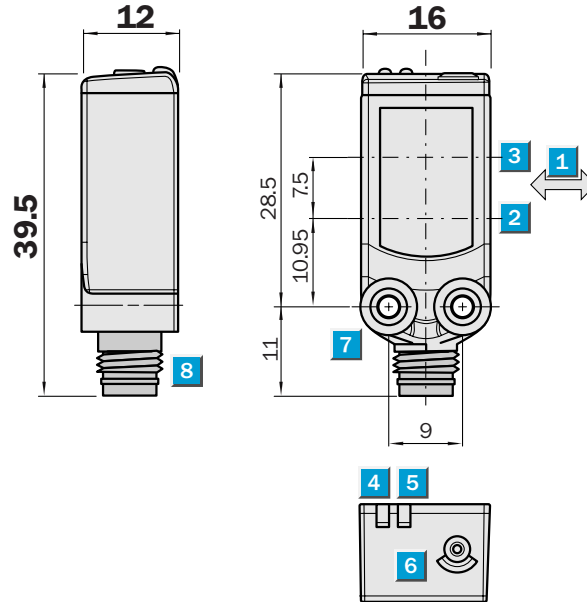

Adjustments possible

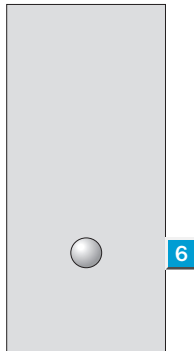

- Standard direction of the material being scanned
- Optical axis, sender
- Optical axis, receiver
- LED indicator yellow, status of received light beam
- LED indicator green, power on
- Teach button
- Mounting hole M3
- Connector

Connection type

WTB4-3N1164

WTB4-3P2262

WTB4-3N2162

WTB4-3N3162

WTB4-3P2162

WTB4-3P3162

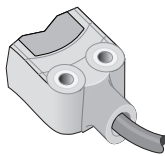

4 x 0.14 mm²

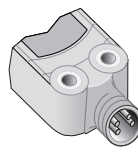

M8, 4-pin

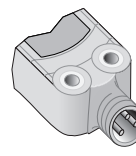
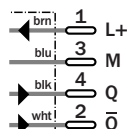

M8, 3-pin

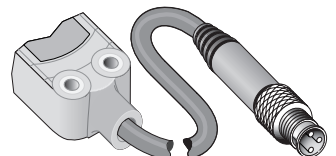
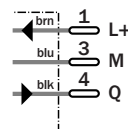

M8, 3-pin

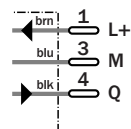

WTB4-3N1362

WTB4-3P2264

WTB4-3P1362

M8, 4-pin

3 x 0.14 mm²

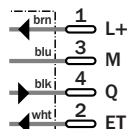
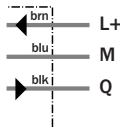

See chapter Accessories

Connector, M8, 3-pin

Connector, M8, 4-pin

Mounting systems

Technical data		WTB4-3	N1164	N1362	N2162	N3162	P1362	P2162	P2262	P2264	P3162
Scanning distance typ. max.	4 ... 150 mm										
Operating distance	15 ... 150 mm										
Adjustment of operating distance	Teach-in: single teach button & cable ¹⁾										
	Teach-in: single teach button										
Light source, light type	Pin Point LED, Red light, 650 nm ²⁾										
Light spot diameter	7 mm at 50 mm distance										
Supply voltage V _s	DC 10 ... 30 V ³⁾										
Ripple	< 5 V _{pp} ⁴⁾										
Power consumption	≤ 30 mA ⁵⁾										
Switching outputs	NPN, Q										
	PNP, Q										
	PNP antivalent										
Switching mode	Light-switching										
	Complementary										
Output current I _a max	≤ 100 mA										
Response time	< 0.5 ms ⁶⁾										
Switching frequency	1,000 Hz ⁷⁾										
Connection type	Cable, PVC, 2 m ⁸⁾										
	Connector, M8, 3-pin										
	Cable with plug, M8, 3-pin, PVC, 100 mm ⁸⁾										
	Connector, M8, 4-pin										
VDE protection class	⊠										
Circuit protection	V _s connections reverse-polarity protected / Output Q and Q not short-circuit protected / Interference suppression										
Enclosure rating	IP 66, IP 67										
Ambient temperature operation	-40 °C ... +60 °C										
Ambient temperature storage	-40 °C ... +75 °C										
Weight	Approx. 20 g										
Housing material	Bayblend, PMMA										

¹⁾ Extern teach-in: impuls > 2s with voltage V_s for PNP or M for NPN
²⁾ Average service life 100,000 h
³⁾ at T_a = +25 °C
⁴⁾ Limit values
⁵⁾ May not exceed or fall short of
⁶⁾ V_s tolerances
⁷⁾ Without load
⁸⁾ Signal transit time with resistive load
⁷⁾ With light/dark ratio 1:1
⁸⁾ Do not bend below 0 °C

Scanning distance

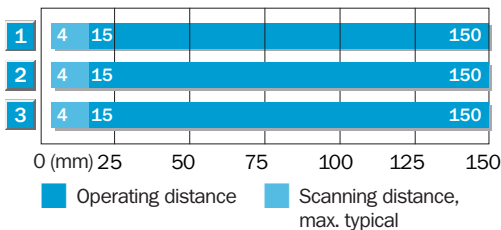

- 1 Scanning range on black, 6 % remission
- 2 Scanning range on grey, 18 % remission
- 3 Scanning range on white, 90 % remission

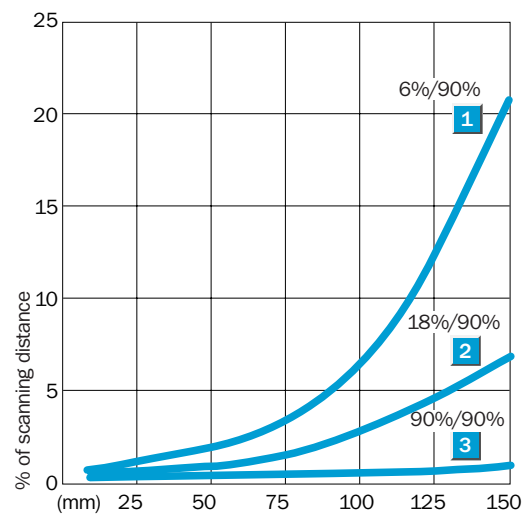

Ordering information	
Type	Part Number
WTB4-3N1164	1 028 090
WTB4-3N1362	1 028 087
WTB4-3N2162	1 028 088
WTB4-3N3162	1 028 089
WTB4-3P1362	1 028 081
WTB4-3P2162	1 028 084
WTB4-3P2262	1 028 085
WTB4-3P2264	1 028 086
WTB4-3P3162	1 028 082

Scanning distance
4 ... 150 mm

Photoelectric proximity switch

- High-precision setting of scanning distance thanks to 5-turn potentiometer
- Object detection almost irrespective of colour and background consistency
- Secure function when mounted opposite other sensors

Dimensional drawing

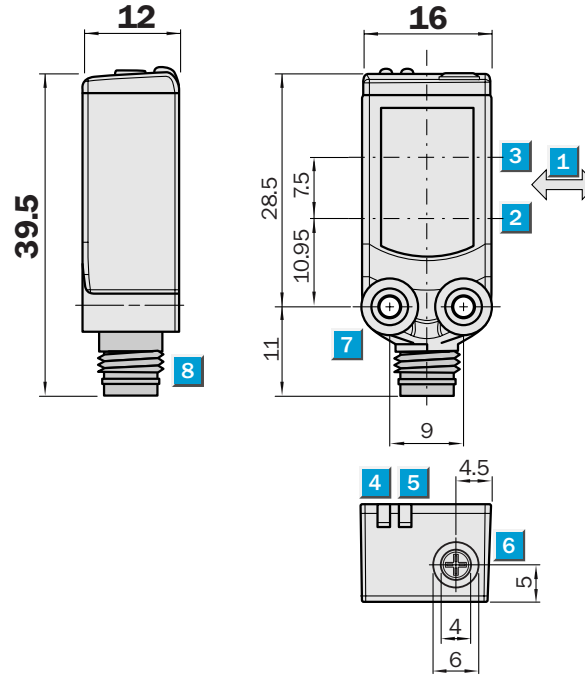

Adjustments possible



- 1 Standard direction of the material being scanned
- 2 Optical axis, sender
- 3 Optical axis, receiver
- 4 LED indicator yellow, status of received light beam
- 5 LED indicator green, power on
- 6 Potentiometer
- 7 Mounting hole M3
- 8 Connector

Connection type

WTB4-3N3161	WTB4-3N1361	WTB4-3N2161	WTB4-3P2261
WTB4-3P3161	WTB4-3P1361	WTB4-3P2161	

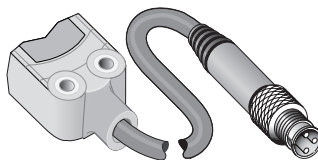

M8, 3-pin

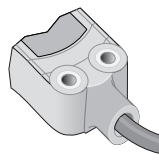
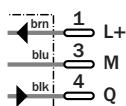

3 x 0.14 mm²

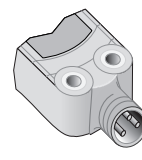
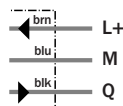

M8, 3-pin

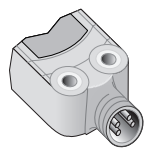

M8, 4-pin

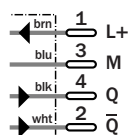

WTB4-3P3261
M8, 4-pin

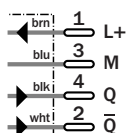

WTB4-3N1161
WTB4-3P1161
4 x 0.14 mm²

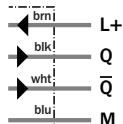

See chapter Accessories

Connector, M8, 3-pin

Connector, M8, 4-pin

Mounting systems

Technical data		WTB4-3	N1161	N1361	N2161	N3161	P1161	P1361	P2161	P2261	P3161	P3261
Scanning distance typ. max.	4 ... 150 mm											
Operating distance	15 ... 150 mm											
Adjustment of operating distance	Potentiometer, 5 revolutions											
Light source, light type	Pin Point LED, Red light, 650 nm ¹⁾											
Light spot diameter	7 mm at 50 mm distance											
Supply voltage V_s	DC 10 ... 30 V ²⁾											
Ripple	< 5 V _{pp} ³⁾											
Power consumption	≤ 30 mA ⁴⁾											
Switching outputs	NPN antivalent											
	NPN, Q											
	PNP antivalent											
	PNP, Q											
Switching mode	Complementary											
	Light-switching											
Output current I _a max	≤ 100 mA											
Response time	< 0.5 ms ⁵⁾											
Switching frequency	1,000 Hz ⁶⁾											
Connection type	Cable, PVC, 2 m ⁷⁾											
	Connector, M8, 3-pin											
	Cable with plug, M8, 3-pin, PVC, 100 mm ⁷⁾											
	Connector, M8, 4-pin											
	Cable with plug, M8, 4-pin, PVC, 100 mm ⁷⁾											
VDE protection class	⊖											
Circuit protection	V _s connections reverse-polarity protected / Output Q and Q not short-circuit protected / Interference suppression											
Enclosure rating	IP 66, IP 67											
Ambient temperature operation	-40 °C ... +60 °C											
Ambient temperature storage	-40 °C ... +75 °C											
Weight	Approx. 20 g											
Housing material	Bayblend, PMMA											

¹⁾ Average service life 100,000 h at T_a = +25 °C

²⁾ Limit values
³⁾ May not exceed or fall short of

V_s tolerances
⁴⁾ Without load

⁵⁾ Signal transit time with resistive load
⁶⁾ With light/dark ratio 1:1
⁷⁾ Do not bend below 0 °C

Scanning distance

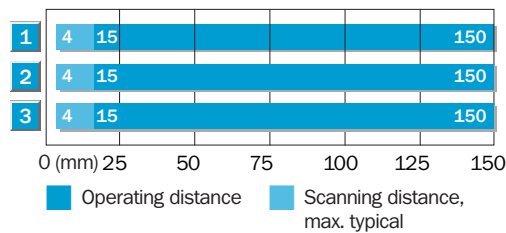

- 1 Scanning range on black, 6% remission
- 2 Scanning range on grey, 18% remission
- 3 Scanning range on white, 90% remission

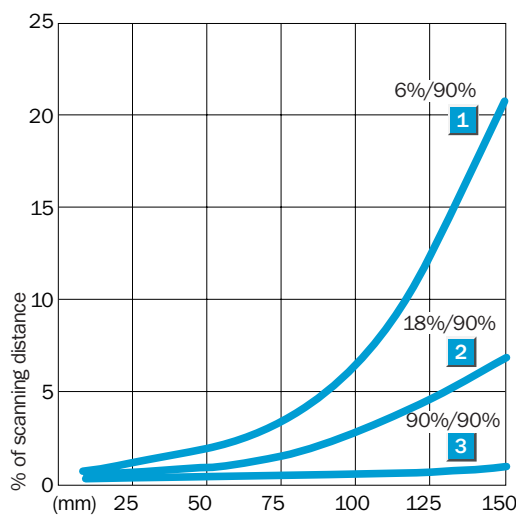

Ordering information

Type	Part Number
WTB4-3N1161	1 028 102
WTB4-3N1361	1 028 101
WTB4-3N2161	1 028 104
WTB4-3N3161	1 028 103
WTB4-3P1161	1 028 096
WTB4-3P1361	1 028 094
WTB4-3P2161	1 028 099
WTB4-3P2261	1 028 100
WTB4-3P3161	1 028 097
WTB4-3P3261	1 028 098

Scanning distance
 4 ... 150 mm
Photoelectric proximity switch

- High-precision setting of scanning distance thanks to 5-turn potentiometer
- Object detection almost irrespective of colour and background consistency
- Secure function when mounted opposite other sensors

Dimensional drawing

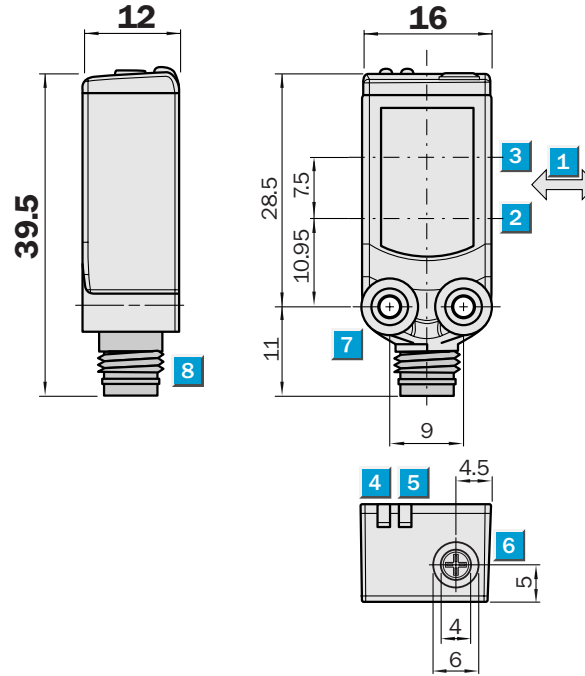

Adjustments possible



- 1 Standard direction of the material being scanned
- 2 Optical axis, sender
- 3 Optical axis, receiver
- 4 LED indicator yellow, status of received light beam
- 5 LED indicator green, power on
- 6 Potentiometer
- 7 Mounting hole M3
- 8 Connector



Connection type

WTB4-3E3161
WTB4-3F3161

WTB4-3E2161
WTB4-3F2161

WTB4-3N1361
WTB4-3F1361

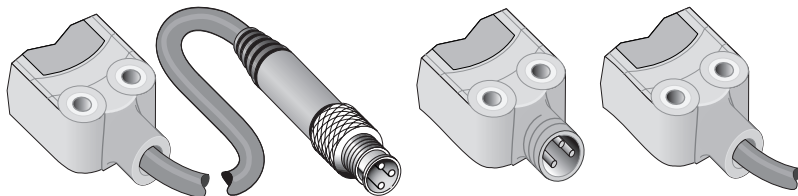

M8, 3-pin

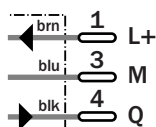

M8, 3-pin

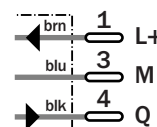

3 x 0.14 mm²

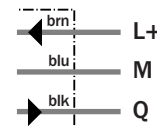

See chapter Accessories
 Connector, M8, 3-pin
 Mounting systems

Technical data		WTB4-3	N1361	E2161	E3161	F1361	F2161	F3161				
Scanning distance typ. max.	4 ... 150 mm											
Operating distance	15 ... 150 mm											
Adjustment of operating distance	Potentiometer, 5 revolutions											
Light source, light type	Pin Point LED, Red light, 650 nm ¹⁾											
Light spot diameter	7 mm at 50 mm distance											
Supply voltage V _s	DC 10 ... 30 V ²⁾											
Ripple	< 5 V _{pp} ³⁾											
Power consumption	≤ 30 mA ⁴⁾											
Switching outputs	NPN, Q											
	PNP, Q											
Switching mode	Dark-switching											
Output current I _a max	≤ 100 mA											
Response time	< 0.5 ms ⁵⁾											
Switching frequency	1,000 Hz ⁶⁾											
Connection type	Cable, PVC, 2 m ⁷⁾											
	Connector, M8, 3-pin											
	Cable with plug, M8, 3-pin, PVC, 100 mm ⁷⁾											
VDE protection class	◆											
Circuit protection	V _s connections reverse-polarity protected / Output Q and Q not short-circuit protected / Interference suppression											
Enclosure rating	IP 66, IP 67											
Ambient temperature operation	-40 °C ... +60 °C											
Ambient temperature storage	-40 °C ... +75 °C											
Weight	Approx. 20 g											
Housing material	Bayblend, PMMA											

¹⁾ Average service life 100,000 h at T_a = +25 °C

²⁾ Limit values

³⁾ May not exceed or fall short of

V_s tolerances
⁴⁾ Without load

⁵⁾ Signal transit time with resistive load

⁶⁾ With light/dark ratio 1:1

⁷⁾ Do not bend below 0 °C

Scanning distance

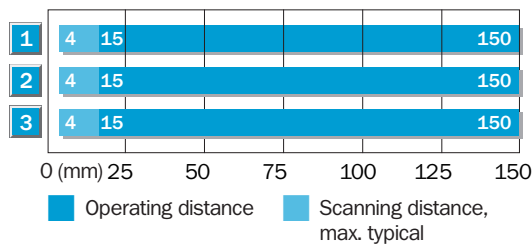

- 1 Scanning range on black, 6% remission
- 2 Scanning range on grey, 18% remission
- 3 Scanning range on white, 90% remission

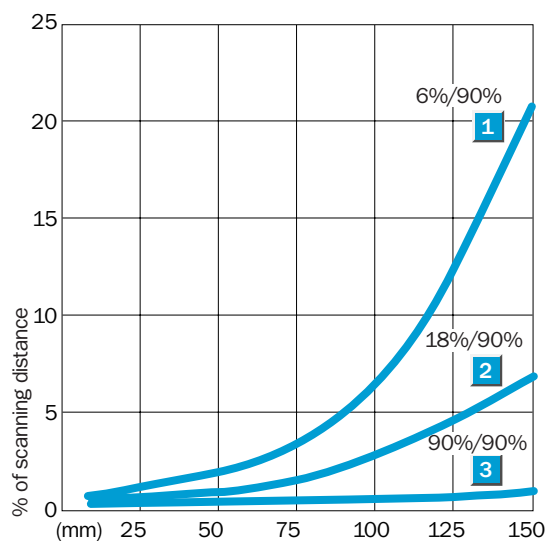

Ordering information

Type	Part Number
WTB4-3N1361	1 028 108
WTB4-3E2161	1 028 110
WTB4-3E3161	1 028 109
WTB4-3F1361	1 028 105
WTB4-3F2161	1 028 107
WTB4-3F3161	1 028 106

Scanning distance
4 ... 50 mm

Photoelectric proximity switch

- Reliable detection of highly transparent and shiny objects at a distance of 20 ... 25 mm
- High-precision setting of scanning distance thanks to 5-turn potentiometer
- Large, homogeneous light spot

Dimensional drawing

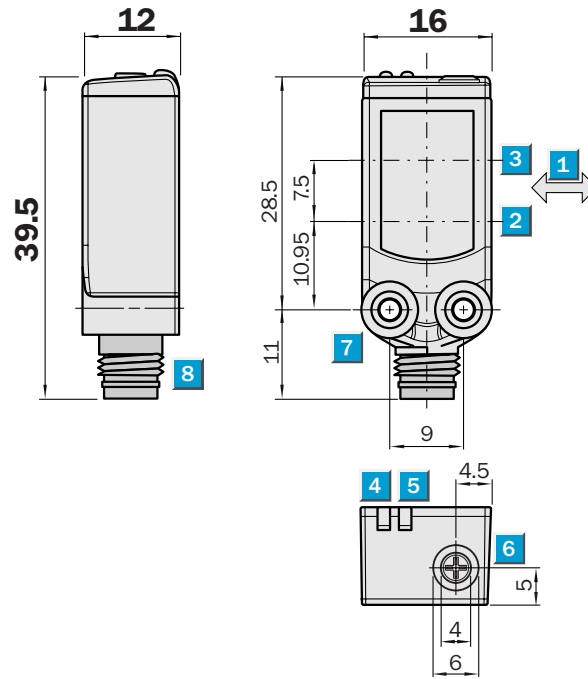

Adjustments possible



- Standard direction of the material being scanned
- Optical axis, sender
- Optical axis, receiver
- LED indicator yellow, status of received light beam
- LED indicator green, power on
- Potentiometer
- Mounting hole M3
- Connector



Connection type

WTV4-3N2181	WTV4-3P2241	WTV4-3N1341	WTV4-3P3441
WTV4-3P2181		WTV4-3P1341	

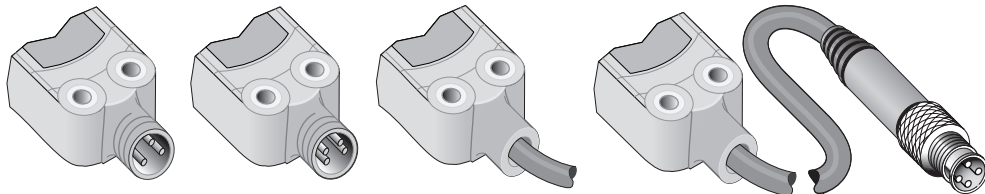

M8, 3-pin M8, 4-pin 3 x 0.14 mm² M12, 4-pin

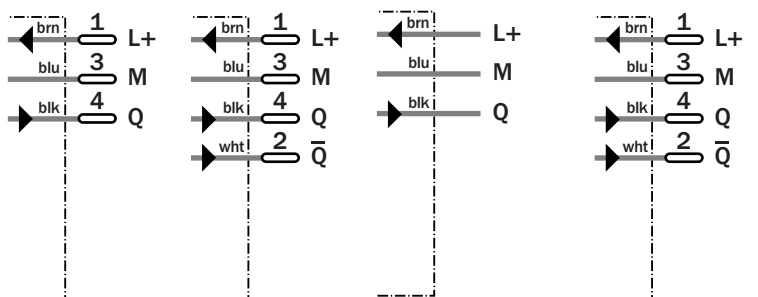

See chapter Accessories

Connector, M12, 4-pin
Connector, M8, 3-pin
Connector, M8, 4-pin
Mounting systems

Technical data		WTV4-3	N1341	N2181	P1341	P2181	P2241	P3441				
Scanning distance typ. max.	4 ... 50 mm											
Operating distance	15 ... 50 mm											
Adjustment of operating distance	Potentiometer, 5 revolutions											
Light source, light type	Pin Point LED, Red light, 650 nm ¹⁾											
Light spot diameter	10 mm at 40 mm distance											
Supply voltage V _s	DC 10 ... 30 V ²⁾											
Ripple	< 5 V _{pp} ³⁾											
Power consumption	≤ 30 mA ⁴⁾											
Switching outputs	NPN, Q											
	PNP, Q											
	PNP antivalent											
Switching mode	Light-switching											
	Complementary											
Output current I _a max	≤ 100 mA											
Response time	< 0.5 ms ⁵⁾											
Switching frequency	1,000 Hz ⁶⁾											
Connection type	Cable, PVC, 2 m ⁷⁾											
	Connector, M8, 3-pin											
	Connector, M8, 4-pin											
	Cable with plug, M12, 4-pin, 150 mm											
VDE protection class	⊠											
Circuit protection	V _s connections reverse-polarity protected / Output Q and Q not short-circuit protected / Interference suppression											
Enclosure rating	IP 66, IP 67											
Ambient temperature operation	-40 °C ... +60 °C											
Ambient temperature storage	-40 °C ... +75 °C											
Weight	Approx. 20 g											
Housing material	Bayblend, PMMA											

¹⁾ Average service life 100,000 h at T_a = +25 °C ²⁾ Limit values ³⁾ May not exceed or fall short of V_s tolerances
⁴⁾ Without load ⁵⁾ Signal transit time with resistive load ⁶⁾ With light/dark ratio 1:1 ⁷⁾ Do not bend below 0 °C

Black-white shift / distance to background

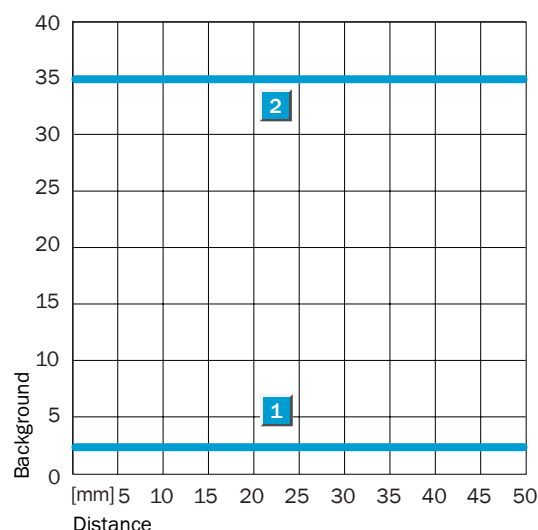

- 1** Black-white shift 90 %/6 %
- 2** Distance to background detecting transparent objects

Ordering information	
Type	Part Number
WTV4-3N1341	1 028 115
WTV4-3N2181	1 028 116
WTV4-3P1341	1 028 111
WTV4-3P2181	1 028 113
WTV4-3P2241	1 028 114
WTV4-3P3441	1 029 582

Scanning distance
 4 ... 150 mm
Photoelectric proximity switch

- Wide-angle light spot with an aperture of 30°
- Reliable detection of objects with slots and holes
- Reliable detection of grid structures

Dimensional drawing

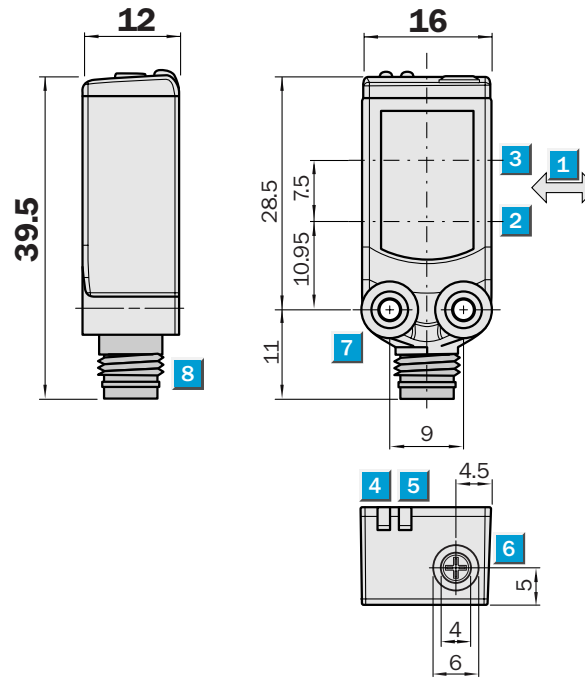

Adjustments possible



- 1 Direction of the sender light line
- 2 Optical axis, sender
- 3 Optical axis, receiver
- 4 LED indicator yellow, status of received light beam
- 5 LED indicator green, power on
- 6 Potentiometer
- 7 Mounting hole M3
- 8 Connector



Connection type

WTB4-3P3171

WTB4-3P2171

WTB4-3N1371

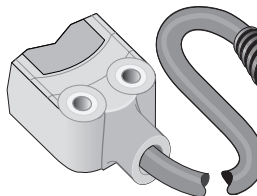

M8, 3-pin

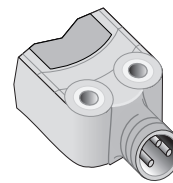

M8, 3-pin

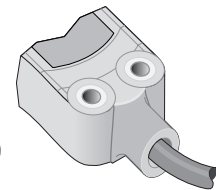

3 x 0.14 mm²

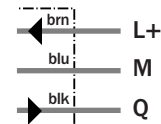
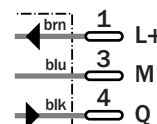
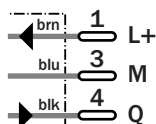

See chapter Accessories

Connector, M8, 3-pin

Mounting systems

Technical data		WTB4-3	N1371	P2171	P3171						
Scanning distance typ. max.	4 ... 150 mm										
Operating distance	15 ... 150 mm										
Adjustment of operating distance	Potentiometer, 5 revolutions										
Light source, light type	Pin Point LED, Red light, 650 nm ¹⁾										
Light spot diameter	5 x 28 mm at 50 mm distance										
Supply voltage V_s	DC 10 ... 30 V ²⁾										
Ripple	< 5 V _{pp} ³⁾										
Power consumption	≤ 30 mA ⁴⁾										
Switching outputs	NPN, Q										
	PNP, Q										
Switching mode	Light-switching										
Output current I_a max	≤ 100 mA										
Response time	< 0.5 ms ⁵⁾										
Switching frequency	1,000 Hz ⁶⁾										
Connection type	Cable, PVC, 2 m ⁷⁾										
	Connector, M8, 3-pin										
	Cable with plug, M8, 3-pin, PVC, 100 mm ⁷⁾										
VDE protection class	⊠										
Circuit protection	V_s connections reverse-polarity protected / Output Q and Q not short-circuit protected / Interference suppression										
Enclosure rating	IP 66, IP 67										
Ambient temperature operation	-40 °C ... +60 °C										
Ambient temperature storage	-40 °C ... +75 °C										
Weight	Approx. 20 g										
Housing material	Bayblend, PMMA										

¹⁾ Average service life 100,000 h at $T_a = +25 °C$

²⁾ Limit values

³⁾ May not exceed or fall short of

V_s tolerances
⁴⁾ Without load

⁵⁾ Signal transit time with resistive load

⁶⁾ With light/dark ratio 1:1

⁷⁾ Do not bend below 0 °C

Scanning distance and light spot width

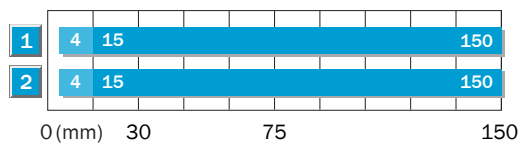

- 1 Scanning range on white, 90 % reflectance
- 2 Scanning range on black, 6 % reflectance

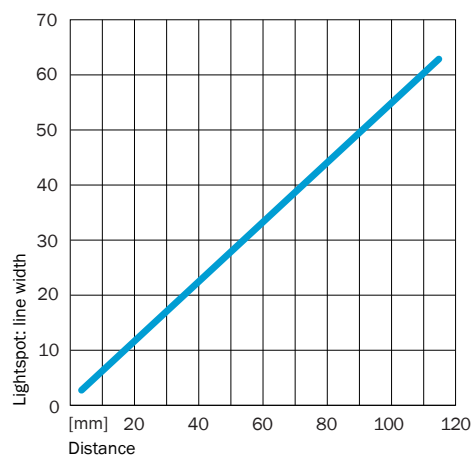

Minimum detectable object

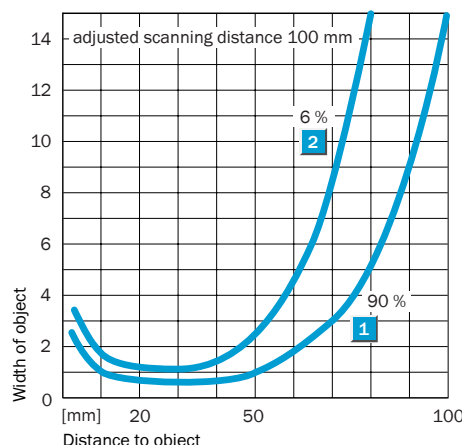
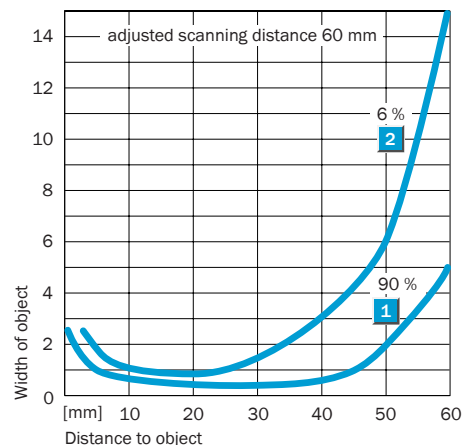

Ordering information

Type	Part Number
WTB4-3N1371	1 028 125
WTB4-3P2171	1 028 123
WTB4-3P3171	1 028 122

Photoelectric proximity switch, WTB4-3, BGS, in Teflon housing



Scanning distance
4 ... 120 mm
Photoelectric proximity switch

- Robust Teflon housing for use in wet and aggressive environments
- Suitable for food applications
- Scanning distance set via Teach-in wire
- Background suppression

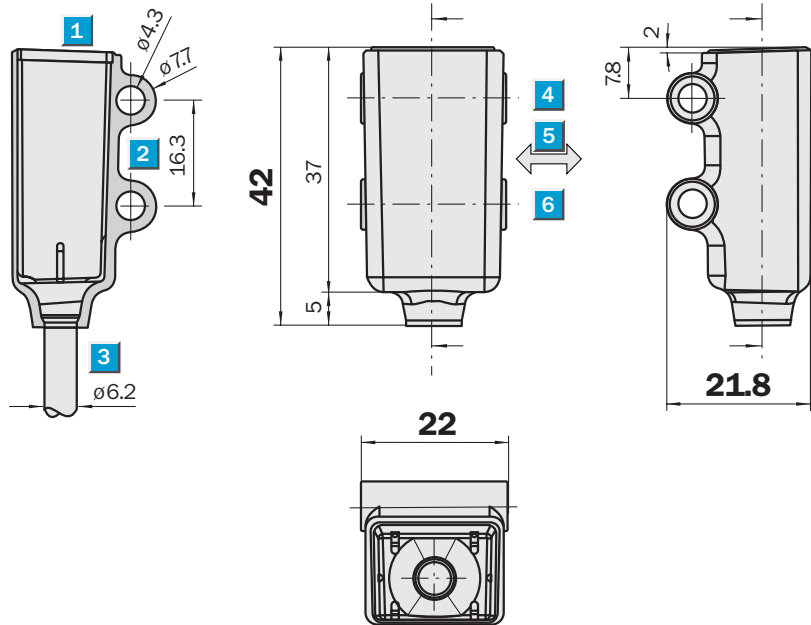
Dimensional drawing

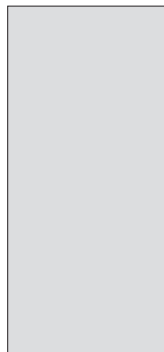

Adjustments possible



- 1 LED signal
- 2 Mounting hole \varnothing 4.3 mm
- 3 Cable 5 m, \varnothing 3.4 mm, 2 m Teflon coated, \varnothing 6.2 mm
- 4 Optical axis, receiver
- 5 Standard direction of the material being scanned
- 6 Optical axis, sender



Connection type

WTB4T-3P1264
 WTB4T-3N1264

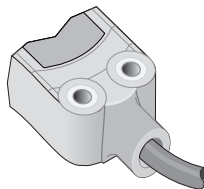

4 x 0.14 mm²

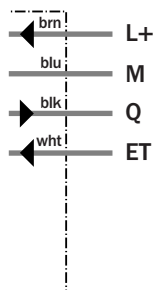

See chapter Accessories

Mounting systems



Technical data		WTB4T-3	P1264	N1264									
Scanning distance typ. max.	4 ... 120 mm												
Operating distance	15 ... 120 mm												
Adjustment of operating distance	Teach-in: External												
Light source, light type	Pin Point LED, Red light, 650 nm ¹⁾												
Light spot diameter	7 mm at 50 mm distance												
Supply voltage V_s	DC 10 ... 30 V ²⁾												
Ripple	< 5 V _{pp} ³⁾												
Power consumption	≤ 30 mA ⁴⁾												
Switching outputs	PNP, Q												
	NPN, Q												
Switching mode	Light-switching												
Output current I _a max	≤ 100 mA												
Response time	< 0.5 ms ⁵⁾												
Switching frequency	1,000 Hz ⁶⁾												
Connection type	Cable, PVC, 5 m ⁷⁾												
VDE protection class	◆												
Circuit protection	V _s connections reverse-polarity protected / Output Q and Q not short-circuit protected / Interference suppression												
Enclosure rating	IP68, IP 69K												
Ambient temperature operation	-40 °C ... +60 °C												
Ambient temperature storage	-40 °C ... +75 °C												
Weight	Approx. 50 g												
Housing material	PTFE/teflon, PMMA												

¹⁾ Average service life 100,000 h at T_a = +25 °C

²⁾ Limit values

³⁾ May not exceed or fall short of

V_s tolerances
⁴⁾ Without load

⁵⁾ Signal transit time with resistive load

⁶⁾ With light/dark ratio 1:1

⁷⁾ Do not bend below 0 °C

Ordering information

Type	Part Number
WTB4T-3P1264	1 028 091
WTB4T-3N1264	1 028 092



Scanning range
0.01 ... 4 m
Photoelectric reflex switch

- Fast and safe alignment through high visibility light spot
- Fast commissioning. Connect, align, ready!
- Easy assembly in slots and guide rails

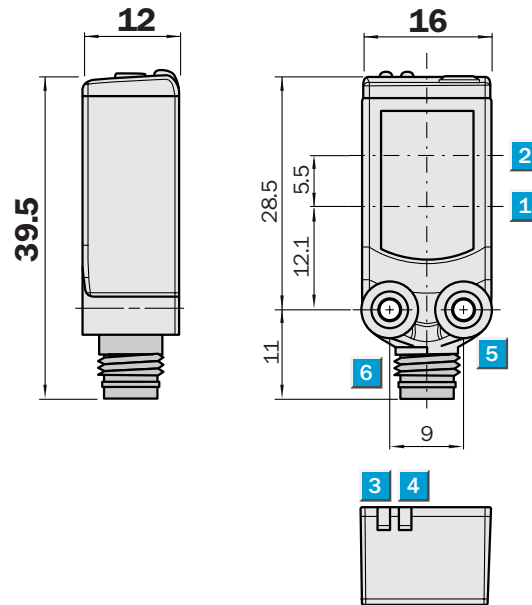
Dimensional drawing

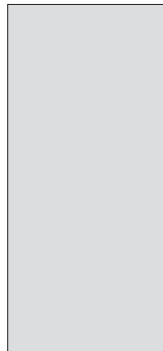

Adjustments possible



- 1 Centre of optical axis, sender
- 2 Centre of optical axis, receiver
- 3 LED signal strength indicator orange: status of received light beam
- 4 LED signal strength indicator green: power on
- 5 Mounting hole M3
- 6 Connector



Connection type

WL4-3N3130	WL4-3N2130	WL4-3P2230	WL4-3N1330
	WL4-3P2130		WL4-3P1330
	WL4-3P3130		

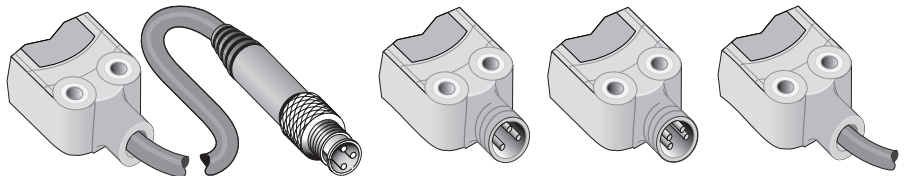

M8, 3-pin

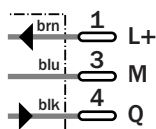

M8, 3-pin

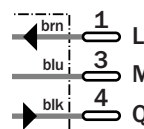

M8, 4-pin

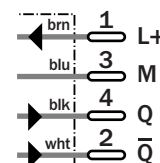

3 x 0.14 mm²

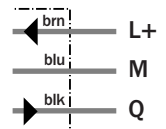

See chapter Accessories

- Connector, M8, 3-pin
- Connector, M8, 4-pin
- Mounting systems

Technical data		WL4-3	N1330	N2130	N3130	P1330	P2130	P2230	P3130			
Scanning range typ. max.	0.01 ... 4 m											
Scanning range, recommended	0.02 ... 3.5 m											
Relating to	Reflector PL80A											
Light source, light type	Pin Point LED, Red light, 650 nm ¹⁾											
Polarisation filter	✓											
Supply voltage V _s	DC 10 ... 30 V ²⁾											
Ripple	≤ 5 V _{pp} ³⁾											
Power consumption	≤ 20 mA ⁴⁾											
Switching outputs	NPN, Q											
	PNP, Q											
	PNP antivalent											
Switching mode	Light-switching											
Output current I _a max	≤ 100 mA											
Response time	< 0.5 ms ⁵⁾											
Switching frequency	1,000 Hz ⁶⁾											
Connection type	Cable, PVC, 2 m ⁷⁾											
	Connector, M8, 3-pin											
	Cable with plug, M8, 3-pin, 100 mm ⁷⁾											
	Connector, M8, 4-pin											
Circuit protection	V _s connections reverse-polarity protected / Output Q and Q not short-circuit protected / Interference suppression											
Enclosure rating	IP 66, IP 67											
Ambient temperature operation	-40 °C ... +60 °C											
Ambient temperature storage	-40 °C ... +75 °C											
Weight	Approx. 30 g											
Housing material	Bayblend, PMMA											

¹⁾ Average service life 100,000 h at T_a = +25 °C

²⁾ Limit values, reverse-polarity protected

operation in short-circuit protected network max. 8 A

³⁾ May not exceed or fall short of

V_s tolerances

⁴⁾ Without load

⁵⁾ Signal transit time with resistive load

⁶⁾ With light/dark ratio 1:1

⁷⁾ Do not bend below 0 °C

Scanning range and operating reserve

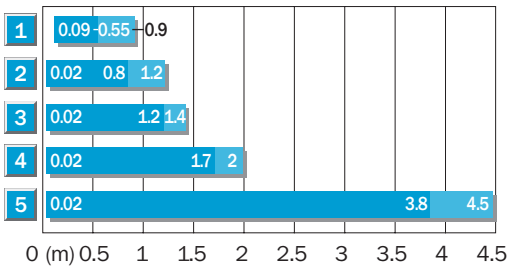

Reflector type	Operating range
1 REF-IRF-56	0.09 ... 0.55 m
2 PL10F	0.02 ... 0.8 m
3 PL20A	0.02 ... 1.2 m
4 PL40A	0.02 ... 1.7 m
5 PL80A	0.02 ... 3.8 m

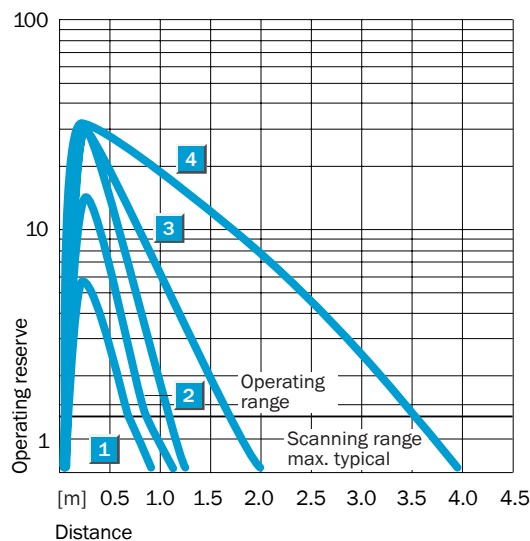

Ordering information

Type	Part Number
WL4-3N1330	1 028 148
WL4-3N2130	1 028 151
WL4-3N3130	1 028 150
WL4-3P1330	1 028 143
WL4-3P2130	1 028 146
WL4-3P2230	1 028 147
WL4-3P3130	1 028 144



Scanning range
0.01 ... 4 m
 Photoelectric reflex switch

- Fast and safe alignment through high visibility light spot
- Fast commissioning. Connect, align, ready!
- Easy assembly in slots and guide rails

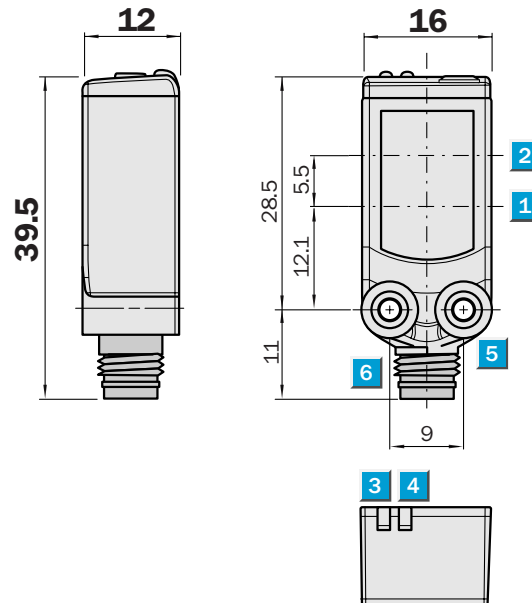
Dimensional drawing

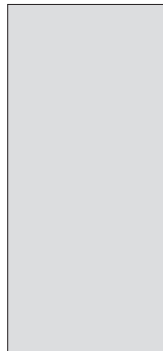

Adjustments possible



- 1 Centre of optical axis, sender
- 2 Centre of optical axis, receiver
- 3 LED signal strength indicator orange: status of received light beam
- 4 LED signal strength indicator green: power on
- 5 Mounting hole M3
- 6 Connector



Connection type

WL4-3E3130	WL4-3E2130	WL4-3E1330
WL4-3F3130	WL4-3F2130	WL4-3F1330

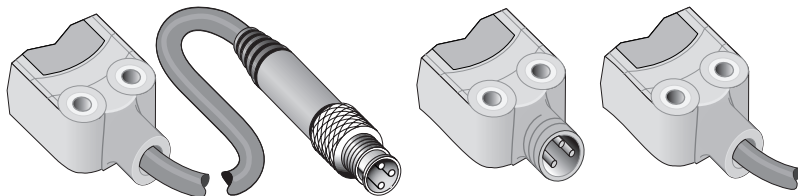

M8, 3-pin

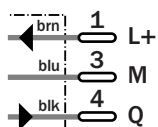

M8, 3-pin

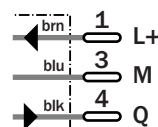

3 x 0.14 mm²

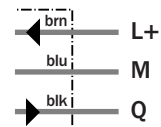

See chapter Accessories
 Connector, M8, 3-pin
 Mounting systems

Technical data		WL4-3	E1330	E2130	E3130	F1330	F2130	F3130				
Scanning range typ. max.	0.01 ... 4 m											
Scanning range, recommended	0.02 ... 3.5 m											
Relating to	Reflector PL80A											
Light source, light type	Pin Point LED, Red light, 650 nm ¹⁾											
Polarisation filter	✓											
Supply voltage V _s	DC 10 ... 30 V ²⁾											
Ripple	≤ 5 V _{pp} ³⁾											
Power consumption	≤ 20 mA ⁴⁾											
Switching outputs	NPN, Q											
	PNP, Q											
Switching mode	Dark-switching											
Output current I _a max	≤ 100 mA											
Response time	< 0.5 ms ⁵⁾											
Switching frequency	1,000 Hz ⁶⁾											
Connection type	Cable, PVC, 2 m ⁷⁾											
	Connector, M8, 3-pin											
	Cable with plug, M8, 3-pin, 100 mm ⁷⁾											
Circuit protection	V _s connections reverse-polarity protected / Output Q and Q not short-circuit protected / Interference suppression											
Enclosure rating	IP 66, IP 67											
Ambient temperature operation	-40 °C ... +60 °C											
Ambient temperature storage	-40 °C ... +75 °C											
Weight	Approx. 30 g											
Housing material	Bayblend, PMMA											

¹⁾ Average service life 100,000 h at T_a = +25 °C
²⁾ Limit values, reverse-polarity protected
³⁾ May not exceed or fall short of
⁴⁾ Without load
⁵⁾ Signal transit time with resistive load
⁶⁾ With light/dark ratio 1:1
⁷⁾ Do not bend below 0 °C

Scanning range and operating reserve

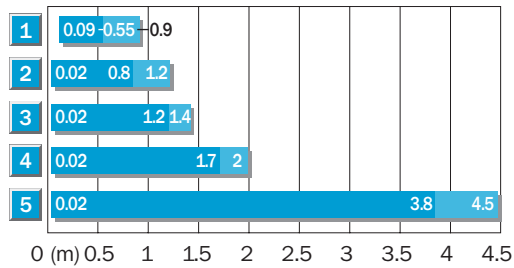

Reflector type	Operating range
1 REF-IRF-56	0.09 ... 0.55 m
2 PL10F	0.02 ... 0.8 m
3 PL20A	0.02 ... 1.2 m
4 PL40A	0.02 ... 1.7 m
5 PL80A	0.02 ... 3.8 m

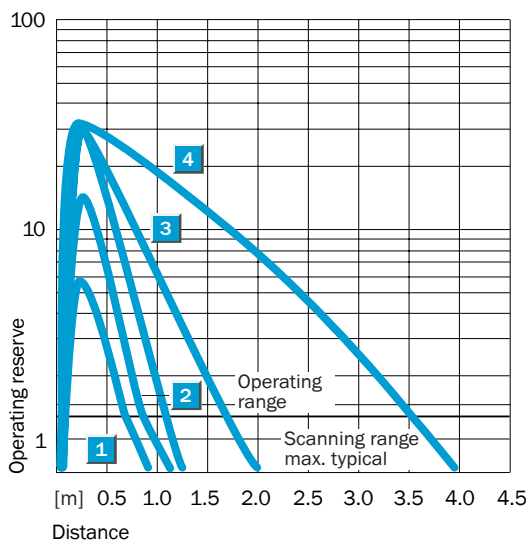

Ordering information	
Type	Part Number
WL4-3E1330	1 028 156
WL4-3E2130	1 028 158
WL4-3E3130	1 028 157
WL4-3F1330	1 028 152
WL4-3F2130	1 028 155
WL4-3F3130	1 028 153



Scanning range
0.01 ... 4 m
 Photoelectric reflex switch

- Fast and safe alignment through high visibility light spot
- Detection of glass objects with an attenuation of > 8%
- Sensitivity setting via wire

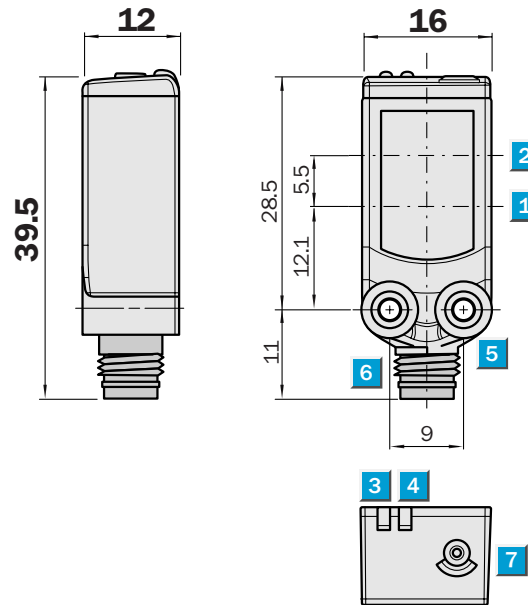
Dimensional drawing

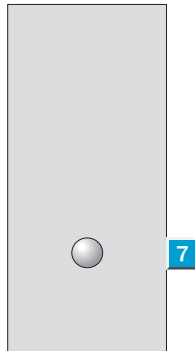

Adjustments possible



- 1 Centre of optical axis, sender
- 2 Centre of optical axis, receiver
- 3 LED signal strength indicator orange: status of received light beam
- 4 LED signal strength indicator green: power on
- 5 Mounting hole M3
- 6 Connector
- 7 Teach button



Connection type

WLG4-3E1134	WLG4-3E2132 WLG4-3F2132 WLG4-3F3132 WLG4-3P2132	WLG4-3F2234	WLG4-3E1332
-------------	--	-------------	-------------

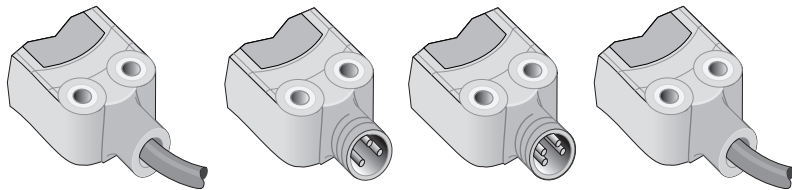

3 x 0.14 mm² M8, 3-pin M8, 4-pin 3 x 0.14 mm²

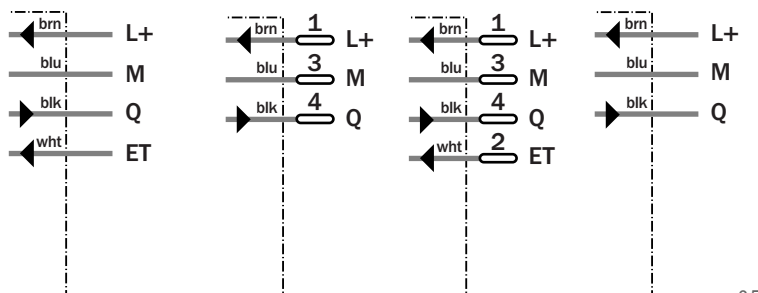

See chapter Accessories
 Connector, M8, 3-pin
 Connector, M8, 4-pin
 Mounting systems

Technical data		WLG4-3	E1134	E1332	E2132	F2132	F2234	F3132	P2132			
Scanning range typ. max.	0.01 ... 4 m											
Scanning range, recommended	0.02 ... 3.5 m											
Relating to	Reflector PL80A											
Sensitivity adjustment	Teach-in: single teach button & cable											
	Teach-in: single teach button											
Light source, light type	Pin Point LED, Red light, 650 nm ¹⁾											
Polarisation filter	✓											
Supply voltage V _s	DC 10 ... 30 V ²⁾											
Ripple	≤ 5 V _{pp} ³⁾											
Power consumption	≤ 20 mA ⁴⁾											
Switching outputs	NPN, Q											
	PNP, Q											
Switching mode	Dark-switching											
	Light-switching											
Output current I _a max	≤ 100 mA											
Response time	< 0.5 ms ⁵⁾											
Switching frequency	1,000 Hz ⁶⁾											
Connection type	Cable, PVC, 2 m ⁷⁾											
	Connector, M8, 3-pin											
	Connector, M8, 4-pin											
	Cable with plug, M8, 3-pin, 100 mm ⁷⁾											
Circuit protection	V _s connections reverse-polarity protected / Output Q and Q not short-circuit protected / Interference suppression											
Enclosure rating	IP 66, IP 67											
Ambient temperature operation	-40 °C ... +60 °C											
Ambient temperature storage	-40 °C ... +75 °C											
Weight	Approx. 30 g											
Housing material	Bayblend, PMMA											

¹⁾ Average service life 100,000 h at T_a = +25 °C

²⁾ Limit values, reverse-polarity protected

operation in short-circuit protected network max. 8 A

³⁾ May not exceed or fall short of

V_s tolerances

⁴⁾ Without load

⁵⁾ Signal transit time with resistive load

⁶⁾ With light/dark ratio 1:1

⁷⁾ Do not bend below 0 °C

Teach-in function

Programming via Teach-in button.

Simple programming:

Position object in the beam and push the button, finished:

LED confirms the Teach-in procedure.

Teach-in values can be stored.

Two operating modes:

Default setting: short Teach-in time (< 8 s); for standard applications;

approx. double reserve via switching threshold;

LED lights continuously.

Precise setting: long Teach-in time (> 8 s);

for precise applications; small switching hysteresis;

LED blinks.

Scanning range and operating reserve

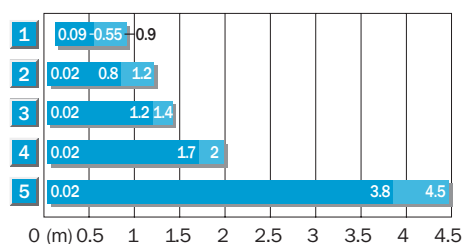

Reflector type	Operating range
1 REF-IRF-56	0.09 ... 0.55 m
2 PL10F	0.02 ... 0.8 m
3 PL20A	0.02 ... 1.2 m
4 PL40A	0.02 ... 1.7 m
5 PL80A	0.02 ... 3.8 m

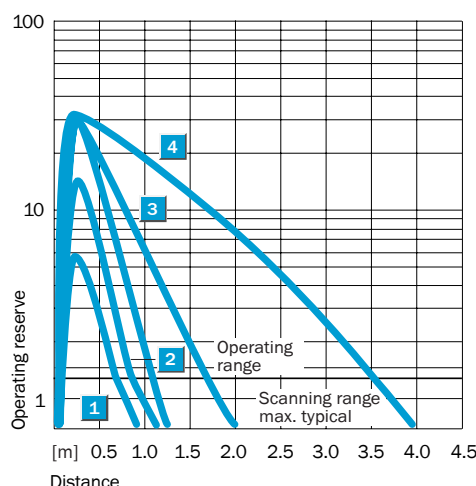

Ordering information

Type	Part Number
WLG4-3E1134	1 028 133
WLG4-3E1332	1 028 131
WLG4-3E2132	1 028 132
WLG4-3F2132	1 028 127
WLG4-3F2234	1 028 130
WLG4-3F3132	1 028 128
WLG4-3P2132	1 029 567



Scanning range
0.1 ... 1 m
 Photoelectric reflex switch

- Fast and safe alignment through high visibility light spot
- Detection of PET bottles and foils with an attenuation of > 8%
- Sensitivity setting via wire

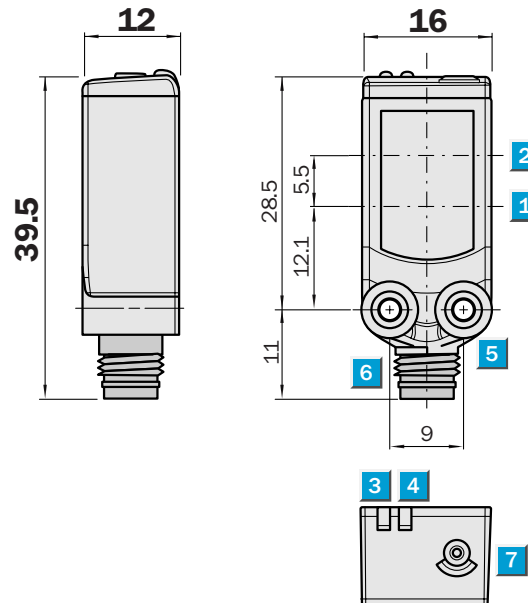
Dimensional drawing

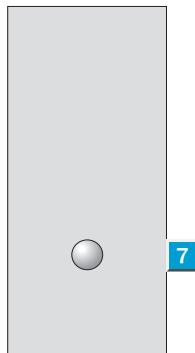

Adjustments possible



- 1 Centre of optical axis, sender
- 2 Centre of optical axis, receiver
- 3 LED signal strength indicator orange: status of received light beam
- 4 LED signal strength indicator green: power on
- 5 Mounting hole M3
- 6 Connector
- 7 Teach button



Connection type

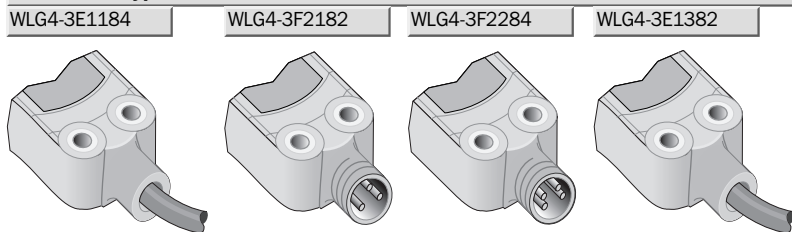

3 x 0.14 mm² M8, 3-pin M8, 4-pin 3 x 0.14 mm²

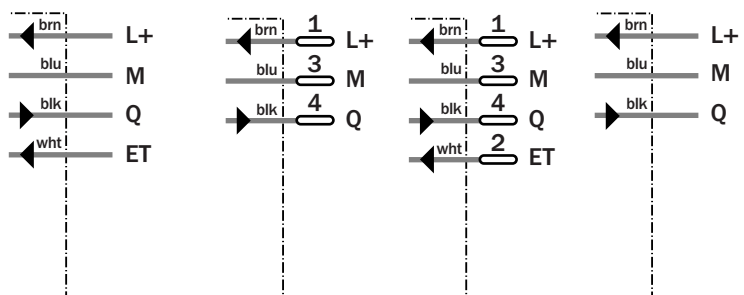

See chapter Accessories

- Connector, M8, 3-pin
- Connector, M8, 4-pin
- Mounting systems

Technical data		WLG4-3	E1184	E1382	F2182	F2284						
Scanning range typ. max.	0.1 ... 1 m											
Scanning range, recommended	0.1 ... 0.6 m											
Relating to	Reflector PL80A											
Sensitivity adjustment	Teach-in: single teach button & cable											
	Teach-in: single teach button											
Light source, light type	Pin Point LED, Red light, 650 nm ¹⁾											
Supply voltage V _s	DC 10 ... 30 V ²⁾											
Ripple	≤ 5 V _{pp} ³⁾											
Power consumption	≤ 20 mA ⁴⁾											
Switching outputs	NPN, Q											
	PNP, Q											
Switching mode	Dark-switching											
Output current I _a max	≤ 100 mA											
Response time	< 0.5 ms ⁵⁾											
Switching frequency	1,000 Hz ⁶⁾											
Connection type	Cable, PVC, 2 m ⁷⁾											
	Connector, M8, 3-pin											
	Connector, M8, 4-pin											
Circuit protection	V _s connections reverse-polarity protected / Output Q and Q not short-circuit protected / Interference suppression											
Enclosure rating	IP 66, IP 67											
Ambient temperature operation	-40 °C ... +60 °C											
Ambient temperature storage	-40 °C ... +75 °C											
Weight	Approx. 30 g											
Housing material	Bayblend, PMMA											
¹⁾ Average service life 100,000 h at T _a = +25 °C	operation in short-circuit protected network max. 8 A											
²⁾ Limit values, reverse-polarity protected	³⁾ May not exceed or fall short of											
	V _s tolerances											
	⁴⁾ Without load											
	⁵⁾ Signal transit time with resistive load											
	⁶⁾ With light/dark ratio 1:1											
	⁷⁾ Do not bend below 0 °C											

Teach-in function

■ Programming via Teach-in button.

■ Simple programming:

Position object in the beam and push the button, finished:

LED confirms the Teach-in procedure.

■ Teach-in values can be stored.

■ Two operating modes:

Default setting: short Teach-in time (< 8 s); for standard applications; approx. double reserve via switching threshold;

LED lights continuously.

Precise setting: long Teach-in time (> 8 s);

for precise applications; small switching hysteresis;

LED blinks.

Ordering information

Type	Part Number
WLG4-3E1184	1 028 140
WLG4-3E1382	1 028 138
WLG4-3F2182	1 028 134
WLG4-3F2284	1 028 137

Scanning range
0 ... 5.5 m

Through-beam photoelectric switch

- Fast and safe alignment through high visibility light spot
- Fast commissioning. Connect, align, ready!
- Easy assembly in slots and guide rails

Dimensional drawing

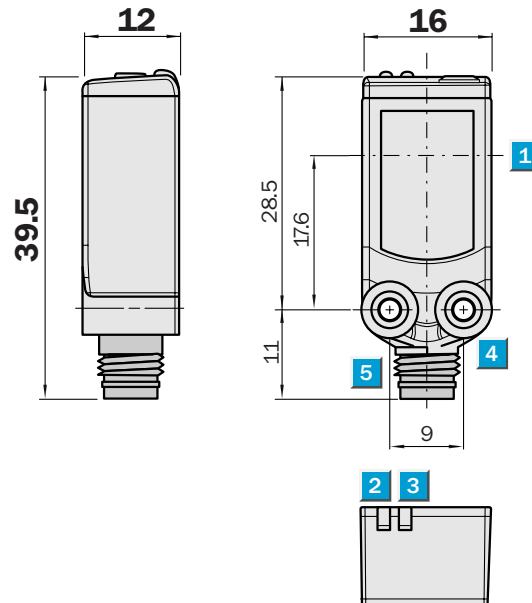

Adjustments possible

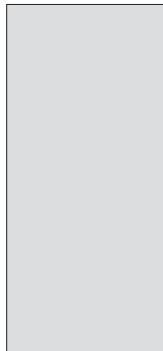

- 1 Centre of optical axis
- 2 LED signal strength indicator orange: status of received light beam
- 3 LED signal strength indicator green: power on
- 4 Mounting hole M3
- 5 Connector

Connection type

WSE4-3N2130	WSE4-3P2230	WSE4-3N1330	WSE4-3P3130
WSE4-3P2130		WSE4-3P1330	
		WSE4-3P1330	

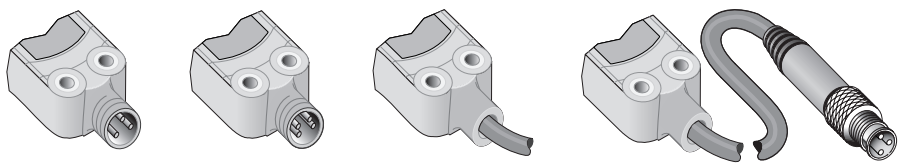

Sender M8, 3-pin M8, 4-pin 3 x 0.14 mm² M8, 3-pin

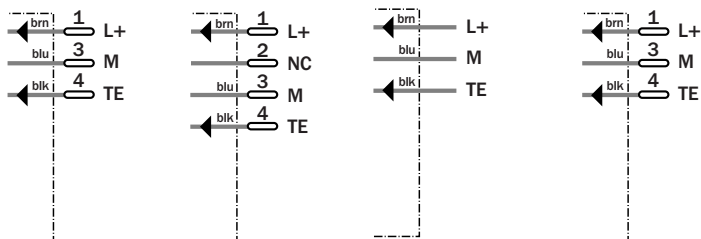

Receiver M8, 3-pin M8, 4-pin 3 x 0.14 mm² M8, 3-pin

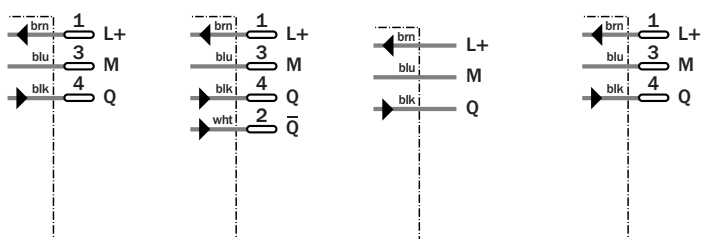

See chapter Accessories
Mounting systems

Technical data		WSE4-3	N1330	N2130	P1330	P1330	P2130	P2230	P3130			
Scanning range typ. max.	0 ... 5.5 m											
Scanning range, recommended	0 ... 6 m											
Light source, light type	Pin Point LED, Red light, 650 nm ¹⁾											
Supply voltage V _s	DC 10 ... 30 V ²⁾											
Ripple	≤ 5 V _{pp} ³⁾											
Power consumption, sender	≤ 20 mA											
Power consumption, receiver	≤ 20 mA											
Switching outputs	NPN, Q											
	PNP, Q											
	PNP											
Switching mode	Light-switching											
	Complementary											
Output current I _a max	≤ 100 mA											
Response time	> 0.5 ms ⁴⁾											
Switching frequency	1,000 Hz ⁵⁾											
Connection type	Cable, 2 m ⁶⁾											
	Connector, M8, 3-pin ⁶⁾											
	Cable, 5 m ⁶⁾											
	Connector, M8, 4-pin											
	Cable with plug, M8, 3-pin, 100 mm ⁶⁾											
Circuit protection	V _s connections reverse-polarity protected / Output Q and Q not short-circuit protected / Interference suppression											
Enclosure rating	IP 66, IP 67											
Ambient temperature operation	-40 °C ... +60 °C											
Ambient temperature storage	-40 °C ... +70 °C											
Weight	Approx. 40 g											
Housing material	Bayblend, PMMA											

¹⁾ Average service life 100,000 h operation in short-circuit protected network max. 8 A V_s tolerances ⁶⁾ Do not bend below 0 °C
²⁾ Limit values, reverse-polarity protected ³⁾ May not exceed or fall short of ⁴⁾ Signal transit time with resistive load ⁵⁾ With light/dark ratio 1:1

Scanning range and operating reserve

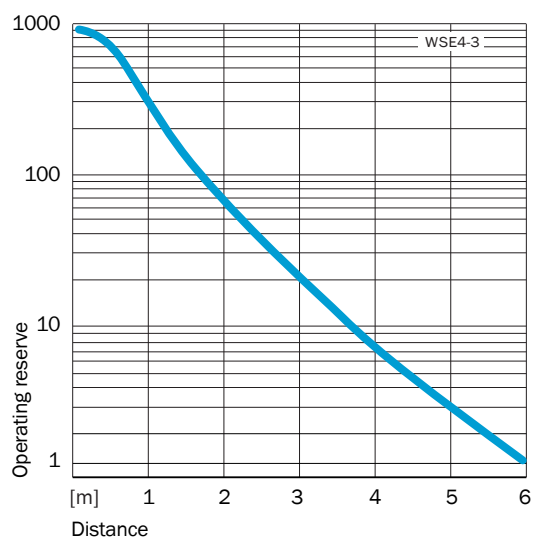
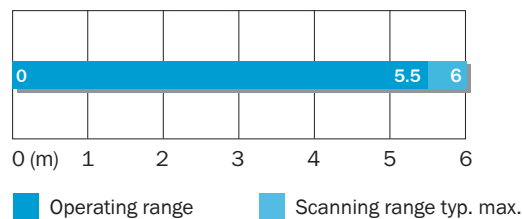

Ordering information	
Type	Part Number
WSE4-3N1330	1 028 164
WSE4-3N2130	1 028 167
WSE4-3P1330	1 028 159
WSE4-3P1330	1 029 645
WSE4-3P2130	1 028 163
WSE4-3P2230	1 028 160
WSE4-3P3130	1 028 161



Scanning range
0 ... 5.5 m

Through-beam photoelectric switch

- Fast and safe alignment through high visibility light spot
- Fast commissioning. Connect, align, ready!
- Easy assembly in slots and guide rails

Dimensional drawing

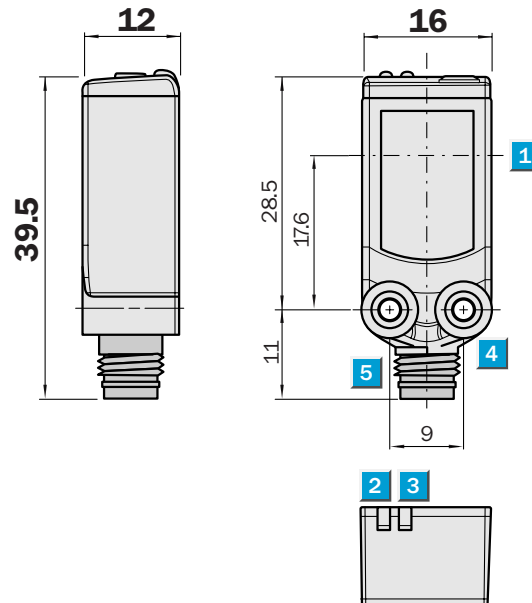

Adjustments possible

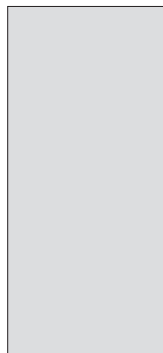

- 1 Centre of optical axis
- 2 LED signal strength indicator orange: status of received light beam
- 3 LED signal strength indicator green: power on
- 4 Mounting hole M3
- 5 Connector

Connection type

WSE4-3E2130
WSE4-3F2130

WSE4-3E1330
WSE4-3F1330

WSE4-3E3130
WSE4-3F3130

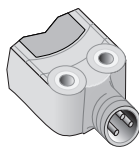

Sender M8, 3-pin

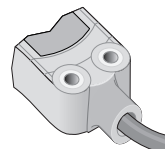
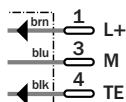

3 x 0.14 mm²

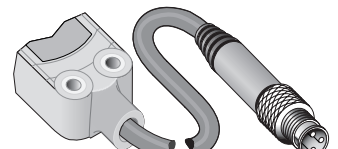
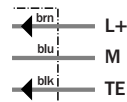

M8, 3-pin

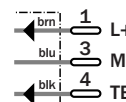

Receiver M8, 3-pin

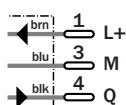

3 x 0.14 mm²

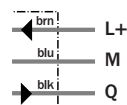

M8, 3-pin



See chapter Accessories
Mounting systems

Technical data		WSE4-3	E1330	E2130	E3130	F1330	F2130	F3130				
Scanning range typ. max.	0 ... 5.5 m											
Scanning range, recommended	0 ... 6 m											
Light source, light type	Pin Point LED, Red light, 650 nm ¹⁾											
Supply voltage V _s	DC 10 ... 30 V ²⁾											
Ripple	≤ 5 V _{pp} ³⁾											
Power consumption, sender	≤ 20 mA											
Power consumption, receiver	≤ 20 mA											
Switching outputs	NPN, Q											
	PNP, Q											
Switching mode	Dark-switching											
Output current I _a max	≤ 100 mA											
Response time	> 0.5 ms ⁴⁾											
Switching frequency	1,000 Hz ⁵⁾											
Connection type	Cable, 2 m ⁶⁾											
	Connector, M8, 3-pin ⁶⁾											
	Cable with plug, M8, 3-pin, 100 mm ⁶⁾											
Circuit protection	V _s connections reverse-polarity protected / Output Q and Q not short-circuit protected / Interference suppression											
Enclosure rating	IP 66, IP 67											
Ambient temperature operation	-40 °C ... +60 °C											
Ambient temperature storage	-40 °C ... +70 °C											
Weight	Approx. 40 g											
Housing material	Bayblend, PMMA											

¹⁾ Average service life 100,000 h operation in short-circuit protected network max. 8 A V_s tolerances ⁶⁾ Do not bend below 0 °C
 at T_a = +25 °C
²⁾ Limit values, reverse-polarity protected ³⁾ May not exceed or fall short of ⁴⁾ Signal transit time with resistive load ⁵⁾ With light/dark ratio 1:1

Scanning range and operating reserve

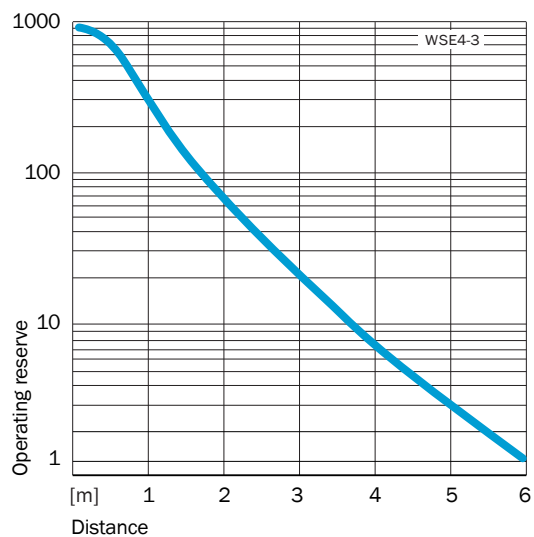
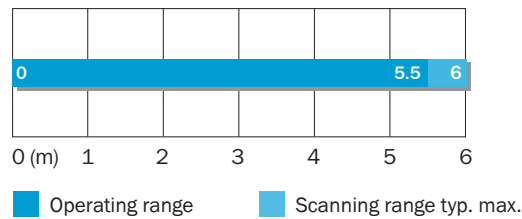

Ordering information	
Type	Part Number
WSE4-3E1330	1 028 172
WSE4-3E2130	1 028 175
WSE4-3E3130	1 028 174
WSE4-3F1330	1 028 168
WSE4-3F2130	1 028 171
WSE4-3F3130	1 028 170



Scanning range
0 ... 3 m

Through-beam photoelectric switch

- Robust Teflon housing for use in wet and aggressive environments
- Suitable for food applications
- Test input

Dimensional drawing

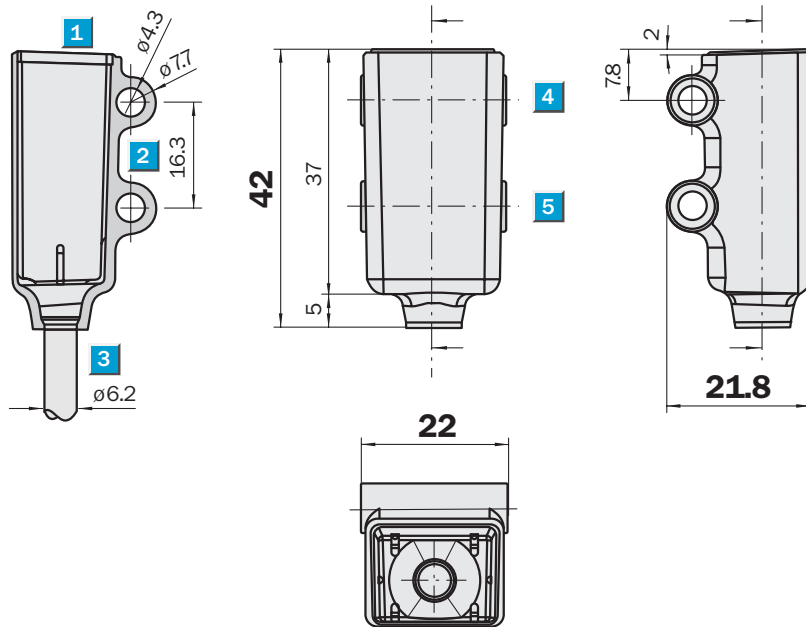

Adjustments possible

- 1 LED signal
- 2 Mounting hole \varnothing 4.3 mm
- 3 Cable 5 m, \varnothing 3.4 mm, 2 m Teflon coated, \varnothing 6.2 mm
- 4 Optical axis, receiver
- 5 Optical axis, sender

Connection type

- WSE4T-3E1430
- WSE4T-3F1430
- WSE4T-3P1430

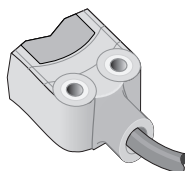

See chapter Accessories

Mounting systems

Sender 3 x 0.14 mm²

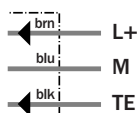

Receiver 3 x 0.14 mm²



Technical data		WSE4T-3	E1430	F1430	P1430								
Scanning range typ. max.	0 ... 3 m												
Scanning range, recommended	0 ... 2.5 m												
Light source, light type	Pin Point LED, Red light, 650 nm ¹⁾												
Supply voltage V _s	DC 10 ... 30 V ²⁾												
Ripple	≤ 5 V _{pp} ³⁾												
Power consumption, sender	≤ 20 mA												
Power consumption, receiver	≤ 20 mA												
Switching outputs	NPN, Q												
	PNP, Q												
Switching mode	Dark-switching												
	Light-switching												
Output current I _a max	≤ 100 mA												
Response time	> 0.5 ms ⁴⁾												
Switching frequency	1,000 Hz ⁵⁾												
Connection type	Cable, 5 m ⁶⁾												
Circuit protection	V _s connections reverse-polarity protected / Output Q and Q not short-circuit protected / Interference suppression												
Enclosure rating	IP68, IP 69K												
Ambient temperature operation	-40 °C ... +60 °C												
Ambient temperature storage	-40 °C ... +70 °C												
Weight	Approx. 60 g												
Housing material	Bayblend, PMMA												

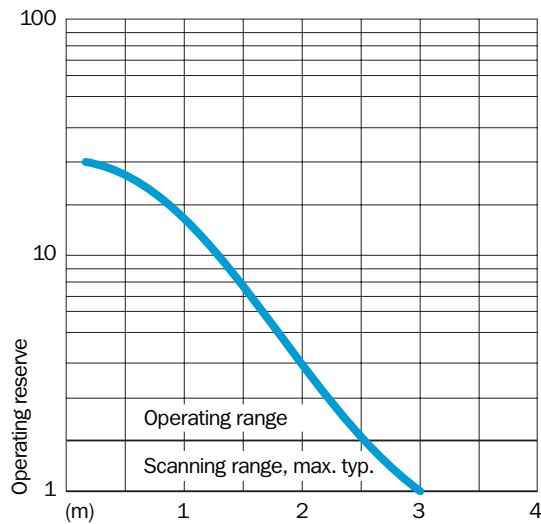
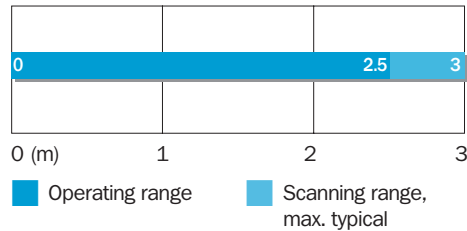

¹⁾ Average service life 100,000 h at T_a = +25 °C
²⁾ Limit values, reverse-polarity protected
³⁾ May not exceed or fall short of operation in short-circuit protected network max. 8 A
⁴⁾ Signal transit time with resistive load
⁵⁾ With light/dark ratio 1:1
⁶⁾ Do not bend below 0 °C
 V_s tolerances

Scanning range and operating reserve



Ordering information	
Type	Part Number
WSE4T-3E1430	1 029 648
WSE4T-3F1430	1 029 647
WSE4T-3P1430	1 029 646

W 100: Miniature photoelectric switch series with large scanning ranges

	Photoelectric proximity switches, BGB
	Photoelectric proximity switches, energetic
	Photoelectric reflex switches



	Through-beam photoelectric switches
--	-------------------------------------

- Energetic photoelectric proximity switch: SD = 900 mm; for standard scanning jobs,
- Photoelectric proximity switch with background blanking: SD = up to 140 mm.

Convenient details simplify handling for assembly, operation start-up and maintenance, for example:

- Sensitivity setting (optionally without),
- Light/dark switch (optionally without),
- Optionally connection cable or M8 plug, 3-pin,
- Easy mounting through integrated mounting hole M3.

The W100 is a complete photoelectric switch series in miniature housing and provides large scanning ranges at an economical price.

The W100 highlights:

- Through-beam photoelectric switches: SR = 15 m;
Accessories: Slotted masks,
- Photoelectric reflex switch with polarizing filter: SR = 6 m (PL80 A),

The M8 plug model especially provides an extremely simple solution for the island technologies being used increasingly. Distributor boxes for plug modules or bus systems. This makes the W100 especially interesting for the industries: storage and conveyor technologies and packaging technologies.



◀ WS/WE100 through-beam photoelectric switch detects filmed objects safely.



▶ WT100 photoelectric proximity switch with background blanking detects reliably conveyed objects.



◀ WL100 photoelectric reflex switch in handling and warehousing systems.

Scanning distance
4 ... 140 mm

Photoelectric proximity switch

- Photoelectric proximity switch with background blanking
- Visible red light as alignment aid
- Switching point adjustable
- Easy mounting through integrated mounting hole M3

Dimensional drawing

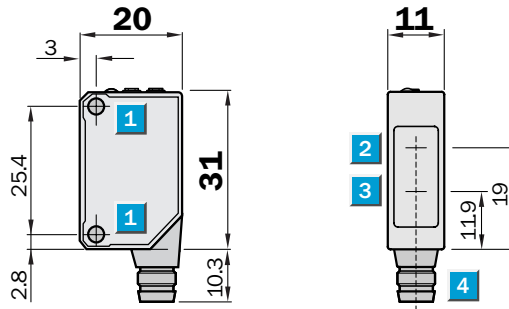

Adjustments possible

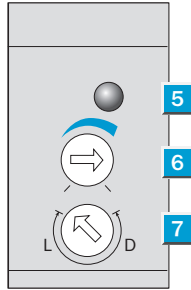

- 1 Mounting hole M 3
- 2 Centre of optical axis, receiver
- 3 Centre of optical axis, sender
- 4 Connector
- 5 LED signal strength indicator orange: switching output active
- 6 Sensitivity adjustment (270 °)
- 7 Light/dark rotary switch: L =light-switching, D =dark-switching



Connection type

WT100-N1419	WT100-N3419	WT100-N4419
WT100-P1419	WT100-P3419	WT100-P4419

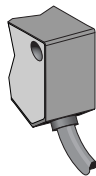

3 x 0.18 mm²

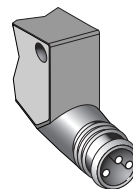
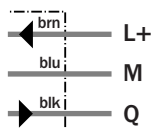

M8, 3-pin

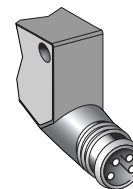
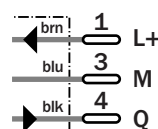

M8, 4-pin

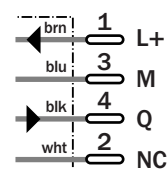

See chapter Accessories

Connector, M8, 3-pin
Connector, M8, 4-pin
Mounting systems

Technical specifications		WT100-	N1419	N3419	N4419	P1419	P3419	P4419				
Scanning distance typ. max.	4 ... 140 mm ¹⁾											
Operating distance	10 ... 100 mm ¹⁾											
Adjustment of operating distance	Potentiometer											
Light source, light type	LED, Red light, 680 nm ²⁾											
Light spot diameter	Approx. 8 mm at 90 mm distance											
Supply voltage V _s	10 ... 30 V DC ³⁾											
Ripple	± 10 % ⁴⁾											
Power consumption	≤ 30 mA ⁵⁾											
Switching outputs	NPN: open collector: Q											
	PNP: open collector: Q											
Switching mode	Light-/dark-switching via rotary switch											
Signal voltage PNP HIGH / LOW	V _s - 1.8 V / approx. 0 V											
Signal voltage NPN HIGH / LOW	Approx. V _s / < 1.8 V											
Output current I _a max	100 mA											
Response time	≤ 0.5 ms ⁶⁾											
Switching frequency	1,000 Hz ⁷⁾											
Connection type	Cable, PVC, 2 m ⁸⁾											
	Connector, M8, 3-pin											
	Connector, M8, 4-pin											
VDE protection class	◆											
Circuit protection	V _s connections reverse-polarity protected / In-/outputs short-circuit protected / Outputs overcurrent and short-circuit protected											
Enclosure rating	IP 65											
Ambient temperature operation	-25 °C ... +55 °C											
Ambient temperature storage	-40 °C ... +70 °C											
Weight	Approx. 53 g											
	Approx. 9 g											
Housing material	ABS, PC											

¹⁾ Object with 90% remission (based on standard white to DIN 5033)
²⁾ Average service life 100,000 h

at T_a = +25°C
³⁾ Limit values, operation in short-circuit protected network max. 8 A

⁴⁾ may not exceed or fall short of V_s tolerances
⁵⁾ without load

⁶⁾ Signal transit time with resistive load
⁷⁾ with light/dark ratio 1:1
⁸⁾ do not bend below 0 °C

Scanning distance

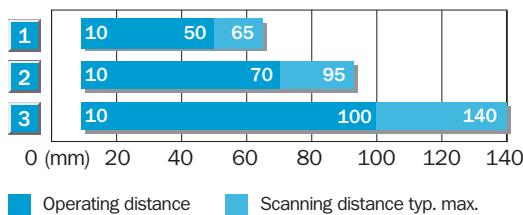

- 1 Scanning range on black, 6 % remission
- 2 Scanning range on grey, 18 % remission
- 3 Scanning range on white, 90 % remission

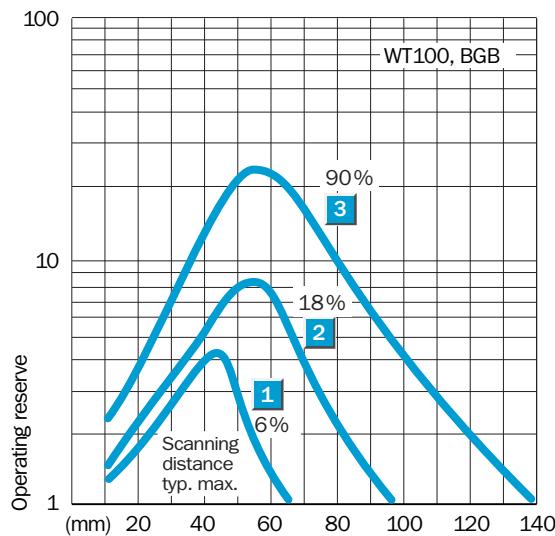

Order information

Type	Order no.
WT100-N1419	6 026 113
WT100-N3419	6 026 115
WT100-N4419	6 028 618
WT100-P1419	6 026 114
WT100-P3419	6 026 116
WT100-P4419	6 028 619

Scanning distance
0 ... 900 mm

Photoelectric proximity switch

- Energetic photoelectric proximity switches for standard applications
- Visible red light as alignment aid
- Switching point adjustable
- Easy mounting through integrated mounting hole M3

Dimensional drawing

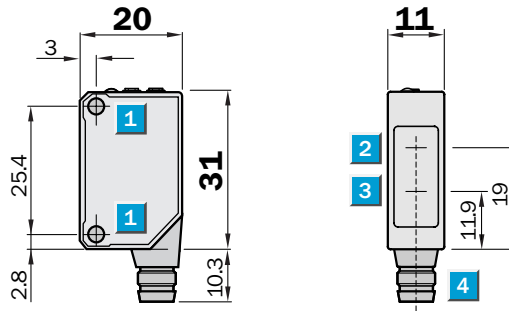

Adjustments possible

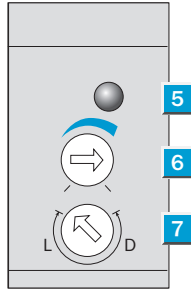

- 1 Mounting hole M 3
- 2 Centre of optical axis, receiver
- 3 Centre of optical axis, sender
- 4 Connector
- 5 LED signal strength indicator orange: switching output active
- 6 Sensitivity adjustment (270 °)
- 7 Light/dark rotary switch: L =light-switching, D =dark-switching



Connection type

WT100-N1439	WT100-N3439	WT100-N4439
WT100-P1439	WT100-P3439	WT100-P4439

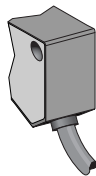

3 x 0.18 mm²

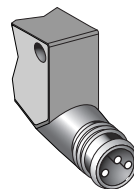
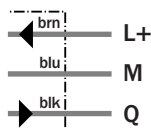

M8, 3-pin

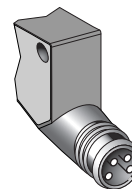
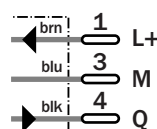

M8, 4-pin

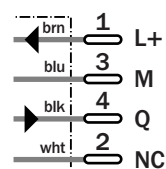

See chapter Accessories

- Connector, M8, 3-pin
- Connector, M8, 4-pin
- Mounting systems

Technical specifications		WT100-	N1439	N3439	N4439	P1439	P3439	P4439				
Scanning distance typ. max.	0 ... 900 mm ¹⁾											
Operating distance	0 ... 700 mm ¹⁾											
Adjustment of operating distance	Potentiometer											
Light source, light type	LED, Red light, 680 nm ²⁾											
Light spot diameter	Approx. 55 mm at 400 mm distance											
Angle of dispersion	Approx. 6.8 °											
Supply voltage V _s	10 ... 30 V DC ³⁾											
Ripple	± 10 % ⁴⁾											
Power consumption	≤ 30 mA ⁵⁾											
Switching outputs	NPN: open collector: Q											
	PNP: open collector: Q											
Switching mode	Light-/dark-switching via rotary switch											
Signal voltage PNP HIGH / LOW	V _s - 1.8 V / approx. 0 V											
Signal voltage NPN HIGH / LOW	Approx. V _s / < 1.8 V											
Output current I _a max	100 mA											
Response time	≤ 0.5 ms ⁶⁾											
Switching frequency	1,000 Hz ⁷⁾											
Connection type	Cable, PVC, 2 m ⁸⁾											
	Connector, M8, 3-pin											
	Connector, M8, 4-pin											
VDE protection class	◆											
Circuit protection	V _s connections reverse-polarity protected / In-/outputs short-circuit protected / Outputs overcurrent and short-circuit protected											
Enclosure rating	IP 65											
Ambient temperature operation	-25 °C ... +55 °C											
Ambient temperature storage	-40 °C ... +70 °C											
Weight	Approx. 53 g											
	Approx. 9 g											
Housing material	ABS, PC											

¹⁾ Object with 90% remission (based on standard white to DIN 5033)
²⁾ Average service life 100,000 h

at T_a = +25 °C
³⁾ Limit values, operation in short-circuit protected network max. 8 A

⁴⁾ May not exceed or fall short of V_s tolerances
⁵⁾ without load

⁶⁾ Signal transit time with resistive load
⁷⁾ with light/dark ratio 1:1
⁸⁾ do not bend below 0 °C

Scanning distance

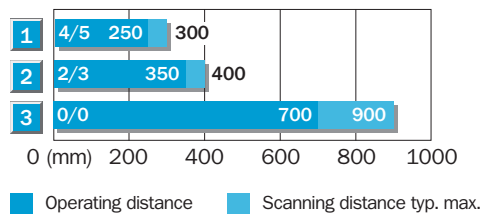

- 1 Scanning range on black, 6 % remission
- 2 Scanning range on grey, 18 % remission
- 3 Scanning range on white, 90 % remission

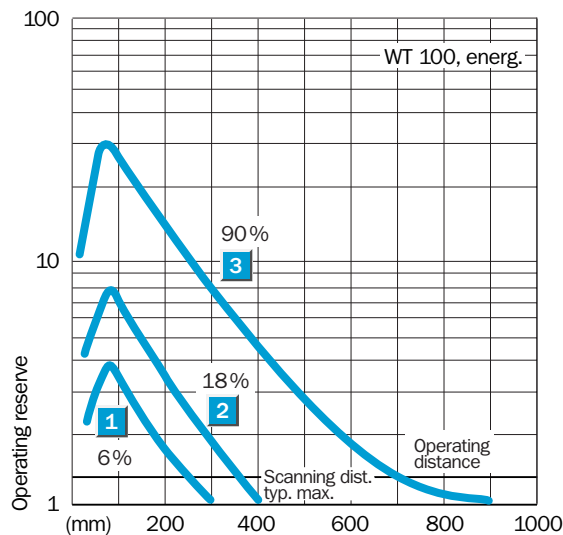

Order information	
Type	Order no.
WT100-N1439	6 026 078
WT100-N3439	6 026 080
WT100-N4439	6 028 614
WT100-P1439	6 026 079
WT100-P3439	6 026 081
WT100-P4439	6 028 615

Scanning range
 0.01 ... 6 m

Photoelectric reflex switch

- Polarization filter and consequently reliable detection of objects with shiny surfaces
- Also suitable for "Diamond Grade" reflective tape
- Sensitivity adjustable
- Visible red light as alignment aid
- Easy mounting through integrated mounting hole M3

Dimensional drawing

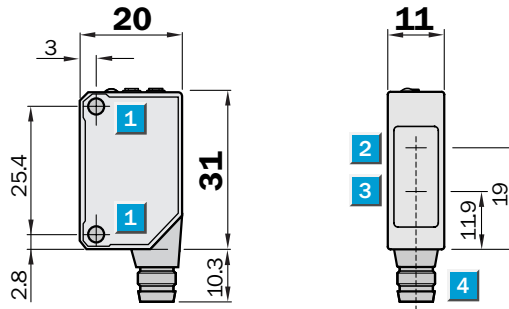

Adjustments possible

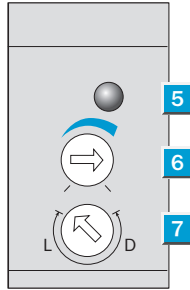

- 1 Mounting hole M 3
- 2 Centre of optical axis, receiver
- 3 Centre of optical axis, sender
- 4 Connector
- 5 LED signal strength indicator orange: switching output active
- 6 Sensitivity adjustment (270 °)
- 7 Light/dark rotary switch: L =light-switching, D =dark-switching



Connection type

WL100-N1439	WL100-N3439	WL100-N4439
WL100-P1439	WL100-P3439	WL100-P4439

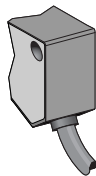

3 x 0.18 mm²

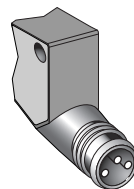
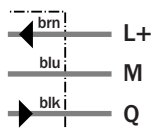

M8, 3-pin

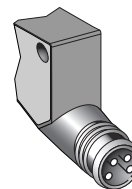
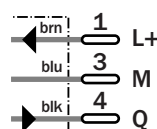

M8, 4-pin

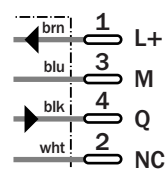

See chapter Accessories

Connector, M8, 3-pin
Connector, M8, 4-pin
Mounting systems
Reflectors

Technical specifications		WL100-	N1439	N3439	N4439	P1439	P3439	P4439				
Scanning range typ. max.	0.01 ... 6 m											
Scanning range, recommended	0.01 ... 5 m											
Relating to	Reflector PL 80 A											
Sensitivity adjustment	Potentiometer											
Light source, light type	LED, Red light, 680 nm ¹⁾											
Light spot diameter	Approx. 250 mm at 3.5 m distance											
Angle of dispersion	Approx. 4 °											
Polarisation filter	✓											
Supply voltage V_s	10 ... 30 V DC ²⁾											
Ripple	± 10 % ³⁾											
Power consumption	≤ 30 mA ⁴⁾											
Switching outputs	NPN: open collector: Q											
	PNP: open collector: Q											
Switching mode	Light-/dark-switching via rotary switch											
Signal voltage PNP HIGH / LOW	V _s - 1.8 V / approx. 0 V											
Signal voltage NPN HIGH / LOW	Approx. V _s / < 1.8 V											
Output current I _a max	100 mA											
Response time	≤ 0.5 ms ⁵⁾											
Switching frequency	1,000 Hz ⁶⁾											
Connection type	Cable, PVC, 2 m ⁷⁾											
	Connector, M8, 3-pin											
	Connector, M8, 4-pin											
VDE protection class	◆											
Circuit protection	V _s connections reverse-polarity protected / In-/outputs short-circuit protected / Outputs overcurrent and short-circuit protected											
Enclosure rating	IP 65											
Ambient temperature operation	-25 °C ... +55 °C											
Ambient temperature storage	-40 °C ... +70 °C											
Weight	Approx. 53 g											
	Approx. 9 g											
Housing material	ABS, PMMA											

¹⁾ Average service life 100,000 h at T_a = +25 °C

²⁾ Limit values, operation in short-circuit

protected network max. 8 A
³⁾ may not exceed or fall short of

V_s tolerances
⁴⁾ without load
⁵⁾ Signal transit time with resistive load

⁶⁾ with light/dark ratio 1:1
⁷⁾ do not bend below 0 °C

Scanning range and operating reserve

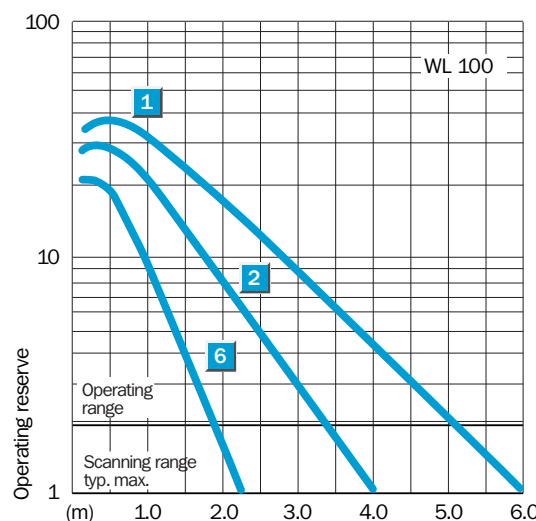
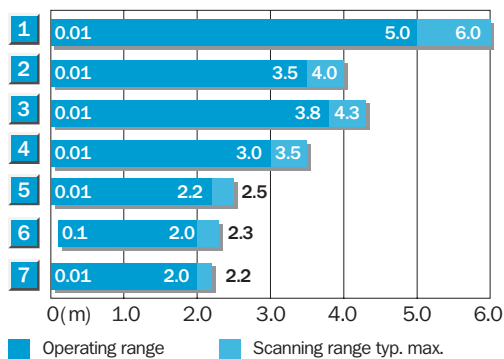

Reflector type	Operating range
1 PL 80 A	0.01 ... 5.0 m
2 P 250	0.01 ... 3.5 m
3 PL 50 A/PL 40 A	0.01 ... 3.8 m
4 PL 30 A/PL 31 A	0.01 ... 3.0 m
5 PL 20 A	0.01 ... 2.2 m
6 Reflective tape Diamond Grade	0.1 ... 2.0 m (100 x 100 mm ²)
7 P 45	0.01 ... 2.0 m

Order information	
Type	Order no.
WL100-N1439	6 026 064
WL100-N3439	6 026 070
WL100-N4439	6 028 604
WL100-P1439	6 026 067
WL100-P3439	6 026 073
WL100-P4439	6 028 607



Scanning range
 0.01 ... 6 m
Photoelectric reflex switch

- Polarization filter and consequently reliable detection of objects with shiny surfaces
- Also suitable for "Diamond Grade" reflective tape
- Light- or dark-switching
- Visible red light as alignment aid
- Easy mounting through integrated mounting hole M3

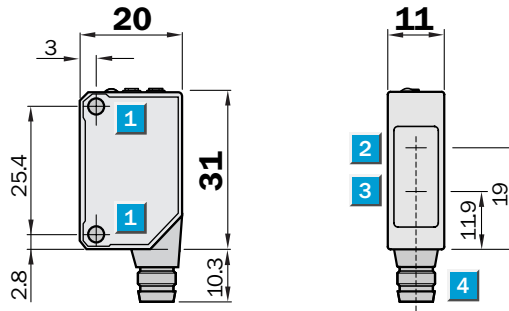
Dimensional drawing

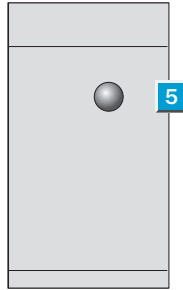

Adjustments possible



- 1** Mounting hole M 3
- 2** Centre of optical axis, receiver
- 3** Centre of optical axis, sender
- 4** Connector
- 5** LED signal strength indicator orange: switching output active



Connection type

WL100-P1239	WL100-P3239	WL100-P4239
WL100-P1339	WL100-P3339	WL100-P4339

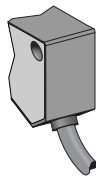

3 x 0.18 mm²

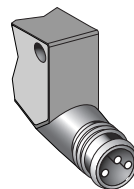
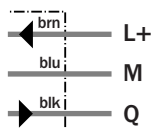

M8, 3-pin

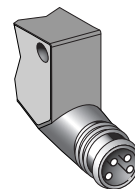
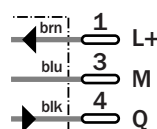

M8, 4-pin

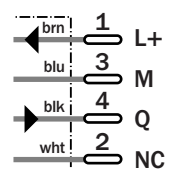

See chapter Accessories

Connector, M8, 3-pin
Connector, M8, 4-pin
Mounting systems
Reflectors

Technical specifications		WL100-	P1239	P1339	P3239	P3339	P4239	P4339				
Scanning range typ. max.	0.01 ... 6 m											
Scanning range, recommended	0.01 ... 5 m											
Relating to	Reflector PL 80 A											
Light source, light type	LED, Red light, 680 nm ¹⁾											
Light spot diameter	Approx. 250 mm at 3.5 m distance											
Angle of dispersion	Approx. 4 °											
Polarisation filter	✓											
Supply voltage V _s	10 ... 30 V DC ²⁾											
Ripple	± 10 % ³⁾											
Power consumption	≤ 30 mA ⁴⁾											
Switching outputs	PNP: open collector: Q											
Switching mode	Dark-switching											
	Light-switching											
Signal voltage PNP HIGH / LOW	V _s - 1.8 V / approx. 0 V											
Output current I _a max	100 mA											
Response time	≤ 0.5 ms ⁵⁾											
Switching frequency	1,000 Hz ⁶⁾											
Connection type	Cable, PVC, 2 m ⁷⁾											
	Connector, M8, 3-pin											
	Connector, M8, 4-pin											
VDE protection class	◆											
Circuit protection	V _s connections reverse-polarity protected / In-/outputs short-circuit protected / Outputs overcurrent and short-circuit protected											
Enclosure rating	IP 65											
Ambient temperature operation	-25 °C ... +55 °C											
Ambient temperature storage	-40 °C ... +70 °C											
Weight	Approx. 53 g											
	Approx. 9 g											
Housing material	ABS, PMMA											

¹⁾ Average service life 100,000 h at T_a = +25 °C

²⁾ Limit values, operation in short-circuit

³⁾ may not exceed or fall short of protected network max. 8 A

V_s tolerances

⁴⁾ without load

⁵⁾ Signal transit time with resistive load

⁶⁾ with light/dark ratio 1:1

⁷⁾ do not bend below 0 °C

Scanning range and operating reserve

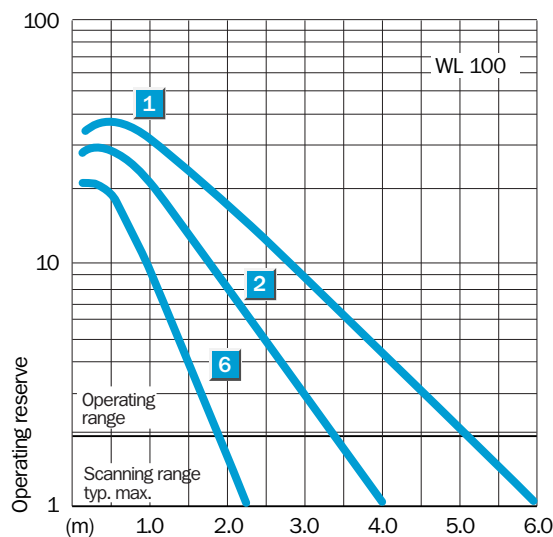
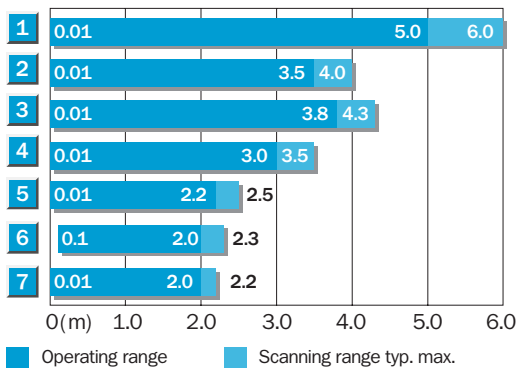

Reflector type	Operating range
1 PL 80 A	0.01 ... 5.0 m
2 P 250	0.01 ... 3.5 m
3 PL 50 A/PL 40 A	0.01 ... 3.8 m
4 PL 30 A/PL 31 A	0.01 ... 3.0 m
5 PL 20 A	0.01 ... 2.2 m
6 Reflective tape Diamond Grade	0.1 ... 2.0 m (100 x 100 mm ²)
7 P 45	0.01 ... 2.0 m

Order information

Type	Order no.
WL100-P1239	6 026 065
WL100-P1339	6 026 066
WL100-P3239	6 026 071
WL100-P3339	6 026 072
WL100-P4239	6 028 605
WL100-P4339	6 028 606

Scanning range
 0.01 ... 6 m

Photoelectric reflex switch

- Polarization filter and consequently reliable detection of objects with shiny surfaces
- Also suitable for "Diamond Grade" reflective tape
- Light- or dark-switching
- Visible red light as alignment aid
- Easy mounting through integrated mounting hole M3

Dimensional drawing

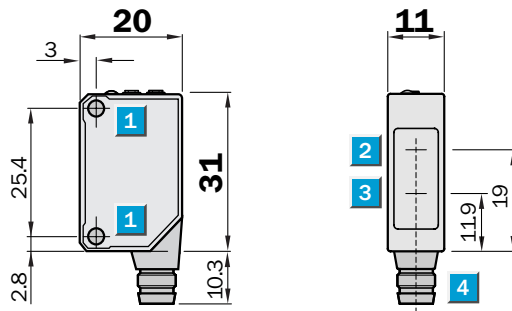

Adjustments possible

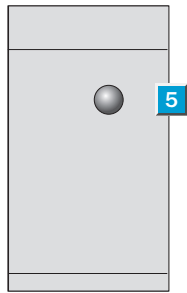

- 1** Mounting hole M 3
- 2** Centre of optical axis, receiver
- 3** Centre of optical axis, sender
- 4** Connector
- 5** LED signal strength indicator orange: switching output active



Connection type

WL100-N1239	WL100-N3239	WL100-N4239
WL100-N1339	WL100-N3339	WL100-N4339

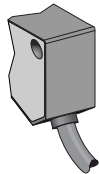

3 x 0.18 mm²

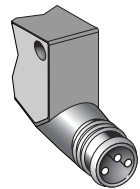
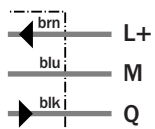

M8, 3-pin

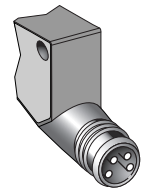
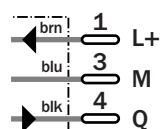

M8, 4-pin

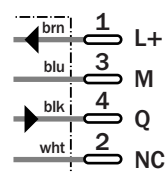

See chapter Accessories

Connector, M8, 3-pin
Connector, M8, 4-pin
Mounting systems
Reflectors

Technical specifications		WL100-	N1239	N1339	N3239	N3339	N4239	N4339
Scanning range typ. max.	0.01 ... 6 m							
Scanning range, recommended	0.01 ... 5 m							
Relating to	Reflector PL 80 A							
Light source, light type	LED, visible red light ¹⁾							
Light spot diameter	Approx. 250 mm at 3.5 m distance							
Angle of dispersion	Approx. 4 °							
Polarisation filter	✓							
Supply voltage V _s	10 ... 30 V DC ²⁾							
Ripple	± 10 % ³⁾							
Power consumption	≤ 30 mA ⁴⁾							
Switching outputs	NPN: open collector: Q							
Switching mode	Dark-switching							
	Light-switching							
Signal voltage NPN HIGH / LOW	Approx. V _s / < 1.8 V							
Output current I _a max	100 mA							
Response time	≤ 0.5 ms ⁵⁾							
Switching frequency	1,000 Hz ⁶⁾							
Connection type	Cable, PVC, 2 m ⁷⁾							
	Connector, M8, 3-pin							
	Connector, M8, 4-pin							
VDE protection class	◆							
Circuit protection	V _s connections reverse-polarity protected / In-/outputs short-circuit protected / Outputs overcurrent and short-circuit protected							
Enclosure rating	IP 65							
Ambient temperature operation	-25 °C ... +55 °C							
Ambient temperature storage	-40 °C ... +70 °C							
Weight	Approx. 53 g							
	Approx. 9 g							
Housing material	ABS, PMMA							

¹⁾ Average service life 100,000 h at T_a = +25 °C

²⁾ Limit values, operation in short-circuit

³⁾ may not exceed or fall short of protected network max. 8 A

V_s tolerances
⁴⁾ without load
⁵⁾ Signal transit time with resistive load

⁶⁾ with light/dark ratio 1:1
⁷⁾ do not bend below 0 °C

Scanning range and operating reserve

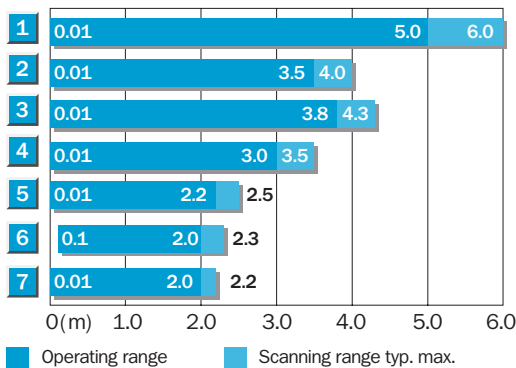

Reflector type	Operating range
1 PL 80 A	0.01 ... 5.0 m
2 P 250	0.01 ... 3.5 m
3 PL 50 A/PL 40 A	0.01 ... 3.8 m
4 PL 30 A/PL 31 A	0.01 ... 3.0 m
5 PL 20 A	0.01 ... 2.2 m
6 Reflective tape Diamond Grade	0.1 ... 2.0 m (100 x 100 mm ²)
7 P 45	0.01 ... 2.0 m

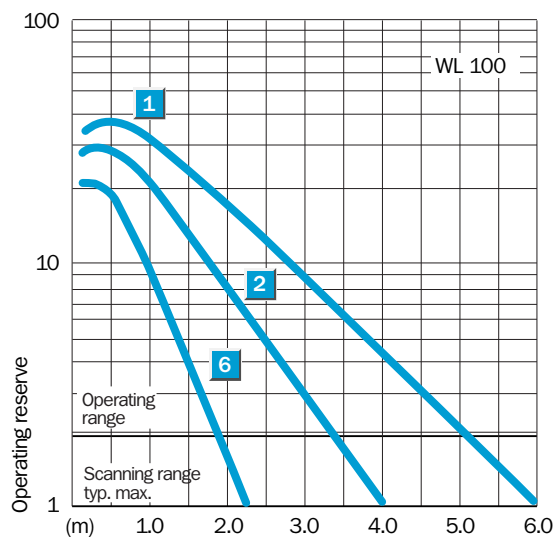

Order information	
Type	Order no.
WL100-N1239	6 026 062
WL100-N1339	6 026 063
WL100-N3239	6 026 068
WL100-N3339	6 026 069
WL100-N4239	6 028 602
WL100-N4339	6 028 603

Scanning range
0.01 ... 3 m

Photoelectric reflex switch

- Ideal for detection of glass or transparent objects
- Detection reliability, min. attenuation 20 %
- Also suitable for "Diamond Grade" reflection tape
- Sensitivity adjustable
- Visible red light as alignment aid
- Easy mounting through integrated mounting hole M3

Dimensional drawing

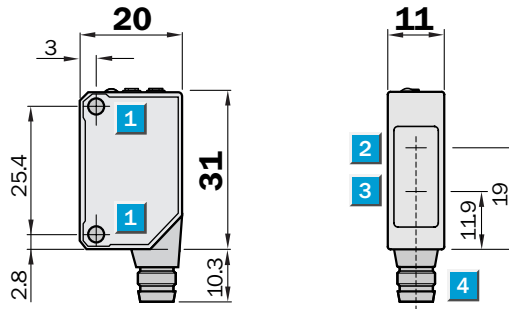

Adjustments possible

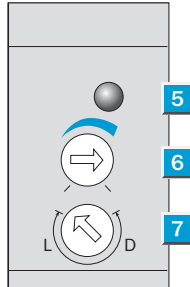

- 1 Mounting hole M 3
- 2 Centre of optical axis, receiver
- 3 Centre of optical axis, sender
- 4 Connector
- 5 LED signal strength indicator orange: switching output active
- 6 Sensitivity adjustment (270°)
- 7 Light/dark rotary switch: L =light-switching, D =dark-switching



Connection type

WL100-N1429	WL100-N3429	WL100-N4429
WL100-P1429	WL100-P3429	WL100-P4429

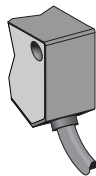

3 x 0.18 mm²

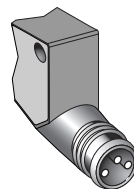
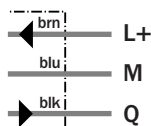

M8, 3-pin

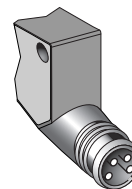
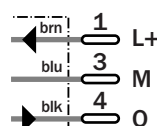

M8, 4-pin

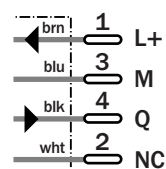

See chapter Accessories

- Connector, M8, 3-pin
- Connector, M8, 4-pin
- Mounting systems
- Reflectors

Technical specifications		WL100-	N1429	N3429	N4429	P1429	P3429	P4429				
Detection of transparent objects	✓											
Attenuation along light beams	≥ 20 %											
Scanning range typ. max.	0.01 ... 3 m											
Scanning range, recommended	0.01 ... 2.6 m											
Relating to	Reflector PL 80 A											
Sensitivity adjustment	Potentiometer											
Light source, light type	LED, Red light, 680 nm ¹⁾											
Light spot diameter	Approx. 200 mm at 2 m distance											
Angle of dispersion	Approx. 4 °											
Supply voltage V_s	10 ... 30 V DC ²⁾											
Ripple	± 10 % ³⁾											
Power consumption	≤ 30 mA ⁴⁾											
Switching outputs	NPN: open collector: Q											
	PNP: open collector: Q											
Switching mode	Light-/dark-switching via rotary switch											
Signal voltage PNP HIGH / LOW	V _s - 1.8 V / approx. 0 V											
Signal voltage NPN HIGH / LOW	Approx. V _s / < 1.8 V											
Output current I _a max	100 mA											
Response time	≤ 0.5 ms ⁵⁾											
Switching frequency	1,000 Hz ⁶⁾											
Connection type	Cable, PVC, 2 m ⁷⁾											
	Connector, M8, 3-pin											
	Connector, M8, 4-pin											
VDE protection class	⊕											
Circuit protection	V _s connections reverse-polarity protected / In-/outputs short-circuit protected / Outputs overcurrent and short-circuit protected											
Enclosure rating	IP 65											
Ambient temperature operation	-25 °C ... +55 °C											
Ambient temperature storage	-40 °C ... +70 °C											
Weight	Approx. 53 g											
	Approx. 9 g											
Housing material	ABS, PMMA											

¹⁾ Average service life 100,000 h at T_a = +25 °C

²⁾ Limit values, operation in short-circuit

³⁾ may not exceed or fall short of protected network max. 8 A

V_s tolerances

⁴⁾ without load

⁵⁾ Signal transit time with resistive load

⁶⁾ with light/dark ratio 1:1

⁷⁾ do not bend below 0 °C

Scanning range and operating reserve

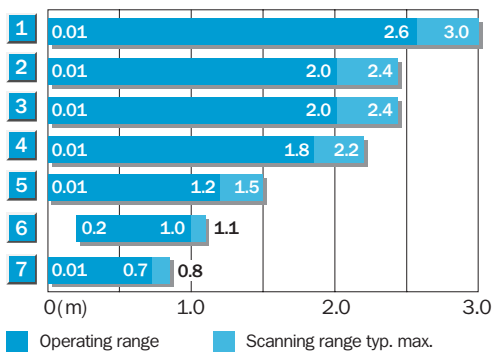

Reflector type	Operating range
1 PL 80 A	0.01 ... 2.6 m
2 P 250	0.01 ... 2 m
3 PL 50 A/PL 40 A	0.01 ... 2 m
4 PL 30 A/PL 31 A	0.01 ... 1.8 m
5 PL 20 A	0.01 ... 1.2 m
6 Reflective tape Diamond Grade	0.2 ... 1.0 m (100 x 100 mm ²)
7 P 45	0.01 ... 0.7 m

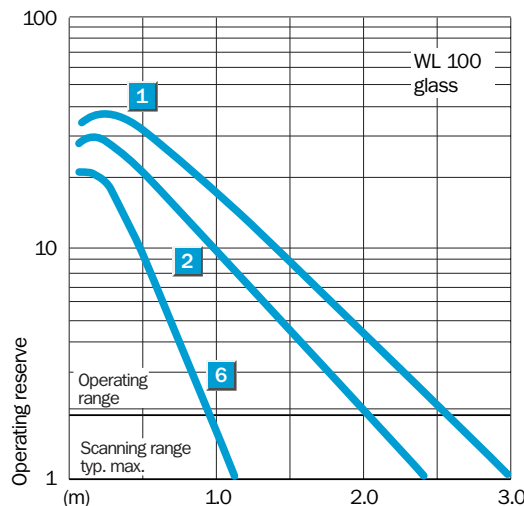

Order information	
Type	Order no.
WL100-N1429	6 027 661
WL100-N3429	6 027 663
WL100-N4429	6 028 610
WL100-P1429	6 027 662
WL100-P3429	6 027 664
WL100-P4429	6 028 611

 **Scanning range**
0 ... 15 m

Through-beam photoelectric

- Polarizing filter tip adapters as accessories
- Slotted masks as accessories for detecting small parts or for positioning jobs
- Sensitivity adjustable
- Visible red light as alignment aid
- Easy mounting through integrated mounting hole M3



Dimensional drawing

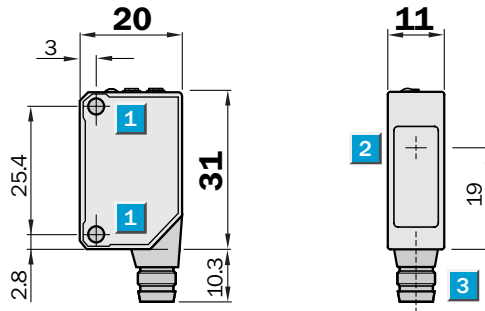

Adjustments possible

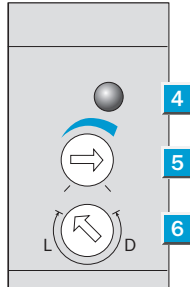

- 1 Mounting hole für M 3
- 2 Centre of optical axis, sender WS 100
- 2 Centre of optical axis, receiver WE 100
- 3 Connector
- 4 LED signal strength indicator orange: switching output active
- 5 Sensitivity adjustment (270 °, WE 100)
- 6 Light/dark rotary switch: L =light-switching, D =dark-switching (WE 100)

Connection type

WS/WE100-N1439	WS/WE100-N3439	WS/WE100-N4439
WS/WE100-P1439	WS/WE100-P3439	WS/WE100-P4439

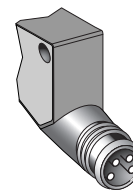
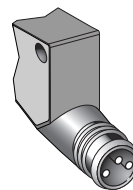
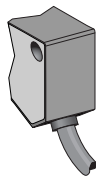

Sender 2 x 0.18 mm²

M8, 3-pin

M8, 4-pin

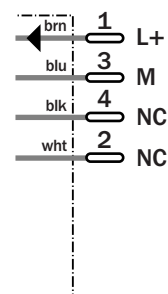
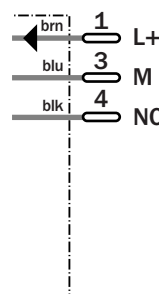
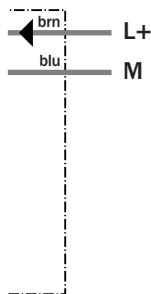

Receiver 3 x 0.18 mm²

M8, 3-pin

M8, 4-pin

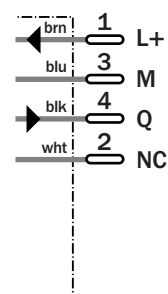
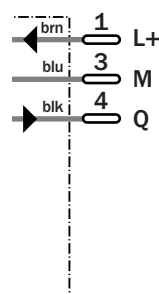
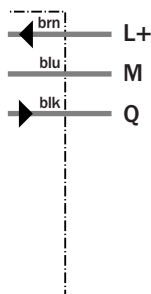

See chapter Accessories

Connector, M8, 3-pin
Connector, M8, 4-pin
Masks
Mounting systems
Polarisation filters

Technical specifications		WS/WE100-	N1439	N3439	N4439	P1439	P3439	P4439				
Scanning range typ. max.	0 ... 15 m											
Scanning range, recommended	0 ... 12 m											
Sensitivity adjustment	Potentiometer											
Light source, light type	LED, Red light, 680 nm ¹⁾											
Light spot diameter	Approx. 650 mm at 12 m distance											
Angle of dispersion	Approx. 3.1 °											
Angle of reception	Approx. 15 °											
Supply voltage V _s	10 ... 30 V DC ²⁾											
Ripple	± 10 % ³⁾											
Power consumption, sender	≤ 15 mA ⁴⁾											
Power consumption, receiver	≤ 20 mA ⁴⁾											
Switching outputs	NPN: open collector: Q PNP: open collector: Q											
Switching mode	Light-/dark-switching via rotary switch											
Signal voltage PNP HIGH / LOW	V _s - 1.8 V / approx. 0 V											
Signal voltage NPN HIGH / LOW	Approx. V _s / < 1.8 V											
Output current I _a max	100 mA											
Response time	≤ 0.5 ms ⁵⁾											
Switching frequency	1,000 Hz ⁶⁾											
Connection type	Cable, PVC, 2 m ⁷⁾											
	Connector, M8, 3-pin											
	Connector, M8, 4-pin											
VDE protection class	◆											
Circuit protection	V _s connections reverse-polarity protected / In-/outputs short-circuit protected (receiver only) / Outputs overcurrent and short-circuit protected (receiver only)											
Enclosure rating	IP 65											
Ambient temperature operation	-25 °C ... +55 °C											
Ambient temperature storage	-40 °C ... +70 °C											
Weight	Approx. 53 g											
	Approx. 9 g											
Housing material	ABS, PC											

¹⁾ Average service life 100,000 h at T_a = +25 °C

²⁾ Limit values, operation in short-circuit

³⁾ may not exceed or fall short of protected network max. 8 A

V_s tolerances

⁴⁾ without load

⁵⁾ Signal transit time with resistive load

⁶⁾ with light/dark ratio 1:1

⁷⁾ do not bend below 0 °C

Scanning range and operating reserve

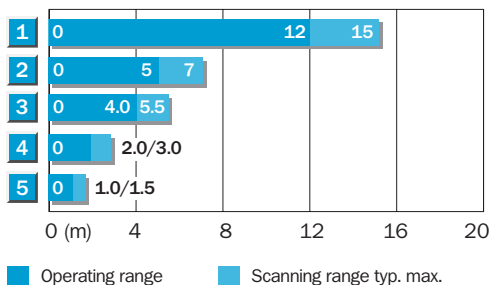

Scanning range reduction when slotted masks are used

1	Without masks/polarization filter
2	With polarization filter tip adapter
3	With slotted mask, width 2.0 mm
4	With slotted mask, width 1.0 mm
5	With slotted mask, width 0.5 mm

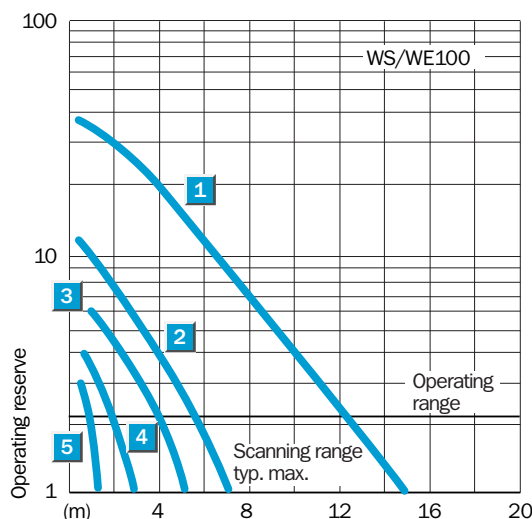

Order information

Type	Order no.
WS/WE100-N1439	6 026 040
WS/WE100-N3439	6 026 046
WS/WE100-N4439	6 028 592
WS/WE100-P1439	6 026 043
WS/WE100-P3439	6 026 049
WS/WE100-P4439	6 028 595

 **Scanning range**
0 ... 15 m

Through-beam photoelectric

- Polarizing filter tip adapters as accessories
- Slotted masks as accessories for detecting small parts or for positioning jobs
- Visible red light as alignment aid
- Easy mounting through integrated mounting hole M3



Dimensional drawing

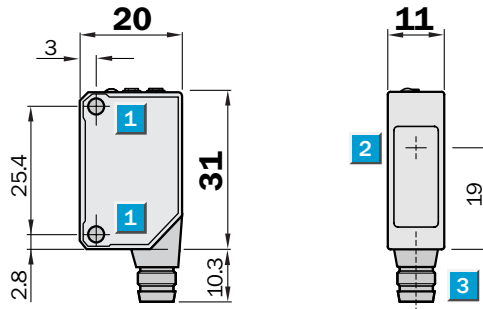

Adjustments possible

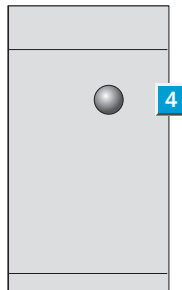

- 1** Mounting hole für M 3
- 2** Centre of optical axis, sender WS 100
- 3** Centre of optical axis, receiver WE 100
- 3** Connector
- 4** LED signal strength indicator orange: switching output active

Connection type

WS/WE100-P1239	WS/WE100-P3239	WS/WE100-P4239
WS/WE100-P1339	WS/WE100-P3339	WS/WE100-P4339

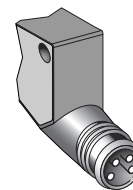
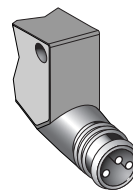
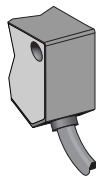

Sender 2 x 0.18 mm²

M8, 3-pin

M8, 4-pin

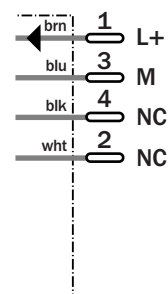
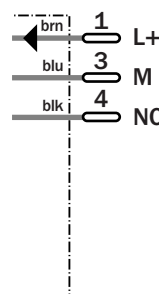
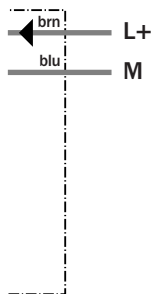

Receiver 3 x 0.18 mm²

M8, 3-pin

M8, 4-pin

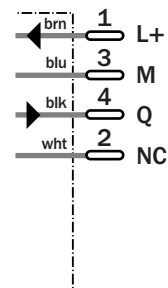
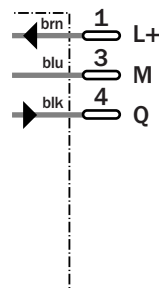
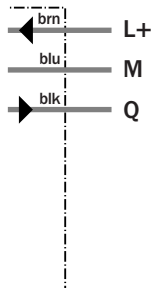

See chapter Accessories

Connector, M8, 3-pin
Connector, M8, 4-pin
Masks
Mounting systems
Polarisation filters

Technical specifications		WS/WE100-	P1239	P1339	P3239	P3339	P4239	P4339				
Scanning range typ. max.	0 ... 15 m											
Scanning range, recommended	0 ... 12 m											
Light source, light type	LED, Red light, 680 nm ¹⁾											
Light spot diameter	Approx. 650 mm at 12 m distance											
Angle of dispersion	Approx. 3.1 °											
Angle of reception	Approx. 15 °											
Supply voltage V _s	10 ... 30 V DC ²⁾											
Ripple	± 10 % ³⁾											
Power consumption, sender	≤ 15 mA ⁴⁾											
Power consumption, receiver	≤ 20 mA ⁴⁾											
Switching outputs	PNP: open collector: Q											
Switching mode	Dark-switching											
	Light-switching											
Signal voltage PNP HIGH / LOW	V _s - 1.8 V / approx. 0 V											
Output current I _a max	100 mA											
Response time	≤ 0.5 ms ⁵⁾											
Switching frequency	1,000 Hz ⁶⁾											
Connection type	Cable, PVC, 2 m ⁷⁾											
	Connector, M8, 3-pin											
	Connector, M8, 4-pin											
VDE protection class	◆											
Circuit protection	V _s connections reverse-polarity protected / In-/outputs short-circuit protected (receiver only) Outputs overcurrent and short-circuit protected (receiver only)											
Enclosure rating	IP 65											
Ambient temperature operation	-25 °C ... +55 °C											
Ambient temperature storage	-40 °C ... +70 °C											
Weight	Approx. 53 g											
	Approx. 9 g											
Housing material	ABS, PC											

¹⁾ Average service life 100,000 h at T_a = +25 °C

²⁾ Limit values, operation in short-circuit

³⁾ may not exceed or fall short of protected network max. 8 A

V_s tolerances
⁴⁾ without load
⁵⁾ Signal transit time with resistive load

⁶⁾ with light/dark ratio 1:1
⁷⁾ do not bend below 0 °C

Scanning range and operating reserve

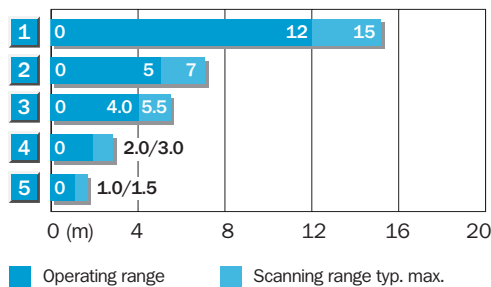

Scanning range reduction when slotted masks are used	
1	Without masks/polarization filter
2	With polarization filter tip adapter
3	With slotted mask, width 2.0 mm
4	With slotted mask, width 1.0 mm
5	With slotted mask, width 0.5 mm

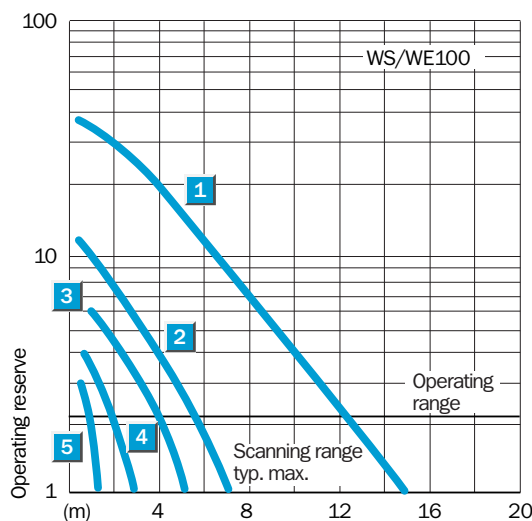

Order information	
Type	Order no.
WS/WE100-P1239	6 026 041
WS/WE100-P1339	6 026 042
WS/WE100-P3239	6 026 047
WS/WE100-P3339	6 026 048
WS/WE100-P4239	6 028 593
WS/WS100-P4339	6 028 594

 **Scanning range**
0 ... 15 m

Through-beam photoelectric

- Polarizing filter tip adapters as accessories
- Slotted masks as accessories for detecting small parts or for positioning jobs
- Visible red light as alignment aid
- Easy mounting through integrated mounting hole M3



Dimensional drawing

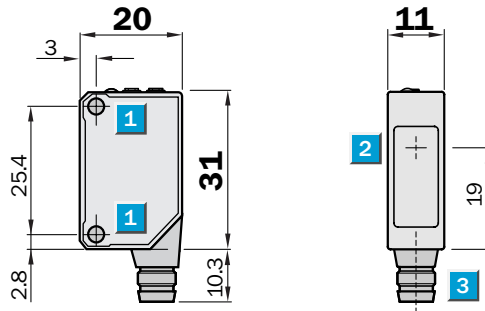

Adjustments possible

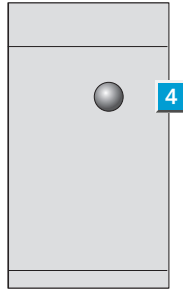

- 1** Mounting hole für M 3
- 2** Centre of optical axis, sender WS 100
- 3** Centre of optical axis, receiver WE 100 onector
- 4** LED signal strength indicator orange: switching output active

Connection type

WS/WE100-N1239	WS/WE100-N3239	WS/WE100-N4239
WS/WE100-N1339	WS/WE100-N3339	WS/WE100-N4339

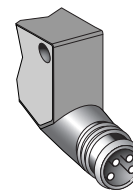
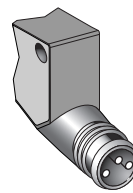
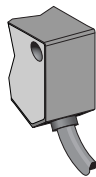

Sender 2 x 0.18 mm²

M8, 3-pin

M8, 4-pin

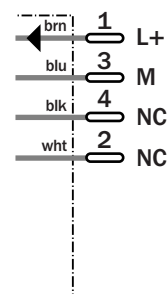
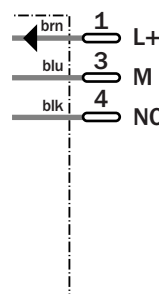
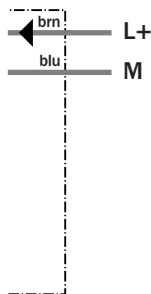

Receiver 3 x 0.18 mm²

M8, 3-pin

M8, 4-pin

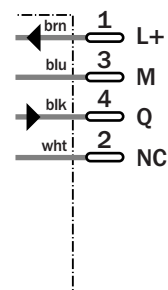
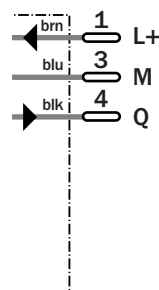
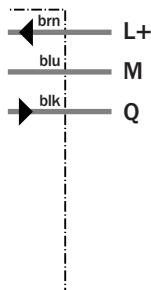

See chapter Accessories

Connector, M8, 3-pin
Connector, M8, 4-pin
Masks
Mounting systems
Polarisation filters

Technical specifications		WS/WE100-	N1239	N1339	N3239	N3339	N4239	N4339				
Scanning range typ. max.	0 ... 15 m											
Scanning range, recommended	0 ... 12 m											
Light source, light type	LED, Red light, 680 nm ¹⁾											
Light spot diameter	Approx. 650 mm at 12 m distance											
Angle of dispersion	Approx. 3.1 °											
Angle of reception	Approx. 15 °											
Supply voltage V_s	10 ... 30 V DC ²⁾											
Ripple	± 10 % ³⁾											
Power consumption, sender	≤ 15 mA ⁴⁾											
Power consumption, receiver	≤ 20 mA ⁴⁾											
Switching outputs	NPN: open collector: Q											
Switching mode	Dark-switching											
	Light-switching											
Signal voltage NPN HIGH / LOW	Approx. V _s / < 1.8 V											
Output current I _a max	100 mA											
Response time	≤ 0.5 ms ⁵⁾											
Switching frequency	1,000 Hz ⁶⁾											
Connection type	Cable, PVC, 2 m ⁷⁾											
	Connector, M8, 3-pin											
	Connector, M8, 4-pin											
VDE protection class	◆											
Circuit protection	V _s connections reverse-polarity protected / In-/outputs short-circuit protected (receiver only) / Outputs overcurrent and short-circuit protected (receiver only)											
Enclosure rating	IP 65											
Ambient temperature operation	-25 °C ... +55 °C											
Ambient temperature storage	-40 °C ... +70 °C											
Weight	Approx. 53 g											
	Approx. 9 g											
Housing material	ABS, PC											

¹⁾ Average service life 100,000 h at T_a = +25 °C

²⁾ Limit values, operation in short-circuit

³⁾ may not exceed or fall short of protected network max. 8 A

V_s tolerances
⁴⁾ without load
⁵⁾ Signal transit time with resistive load

⁶⁾ with light/dark ratio 1:1
⁷⁾ do not bend below 0 °C

Scanning range and operating reserve

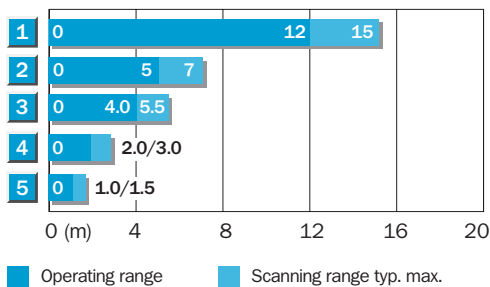

Scanning range reduction when slotted masks are used	
1	Without masks/polarization filter
2	With polarization filter tip adapter
3	With slotted mask, width 2.0 mm
4	With slotted mask, width 1.0 mm
5	With slotted mask, width 0.5 mm

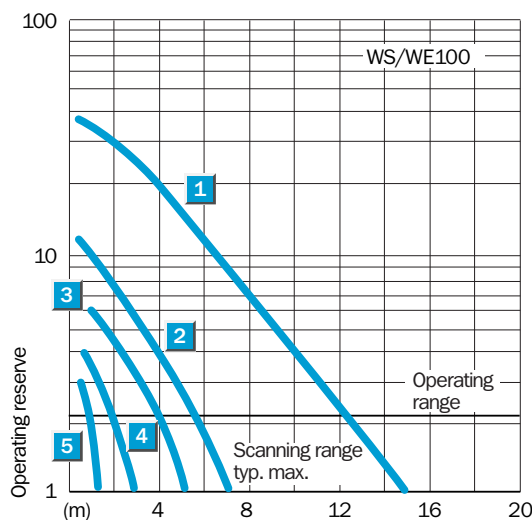

Order information	
Type	Order no.
WS/WE100-N1239	6 026 038
WS/WE100-N1339	6 026 039
WS/WE100-N3239	6 026 044
WS/WE100-N3339	6 026 045
WS/WE100-N4239	6 028 590
WS/WE100-N4339	6 028 591

W140-2: Miniature Photoelectric Switch Series with Large Scanning Ranges

	BGS Photoelectric proximity switches
	Energ. Photoelectric proximity switches
	Photoelectric reflex switches



	Through-beam photoelectric switches
--	--

- Photoelectric proximity switch with adjustable scanning distance and background suppression (BGS): Scanning distance = adjustable up to 500 mm

The integrated W140-2 electronics has parameters comparable with the "big ones" and convenient W140-2 details simplify handling for mounting, operation startup and maintenance, for example:

- Sensitivity/scanning distance adjustment,
- Operating reserve display,
- Optional connection cable or M8 plug, 3 pin or 4 pin.

The W140-2 is a complete photoelectric switch series in miniature housing. It especially provides extensive scanning ranges for challenging requirements. The W140-2 highlights:

- Through-beam photoelectric switch: Scanning range = 16 m. Accessories: Slotted masks, polarisation filter tip adapters
- Photoelectric reflex switch with polarisation filter: Scanning range = 6.5 m (PL 80 A)
- Energetic photoelectric proximity switch: Scanning distance = 1000 mm; for standard scanning jobs

The M8 plug model especially provides an extremely simple solution for the island technologies being used increasingly these days. Distributor boxes for plug modules or bus systems: plug W140-2 and play. All this and more make the W140-2 very interesting for the branches storage and conveyor technology, electronic- and semiconductor industry, packaging machines, and mounting and handling technology.

► WTB140 photoelectric proximity switch checks the presence of components in an assembling machine.

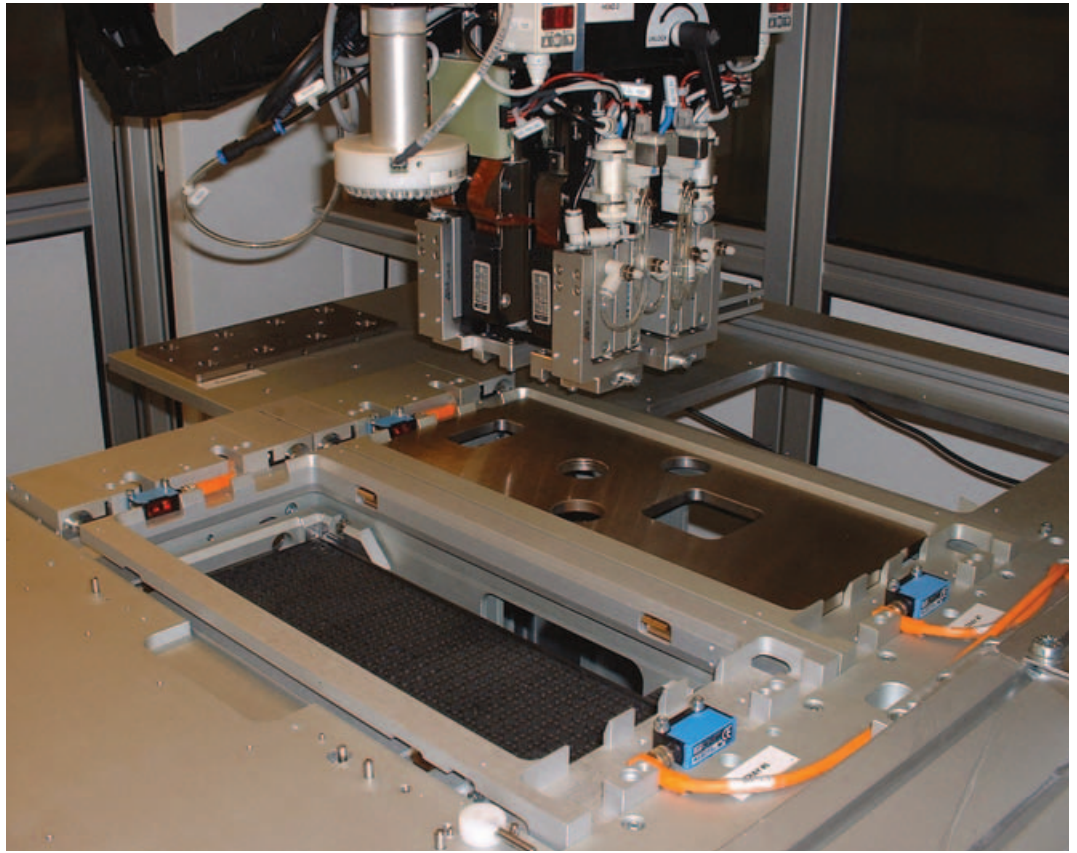

▼ Using two WL140-2, packages can be sorted by size.

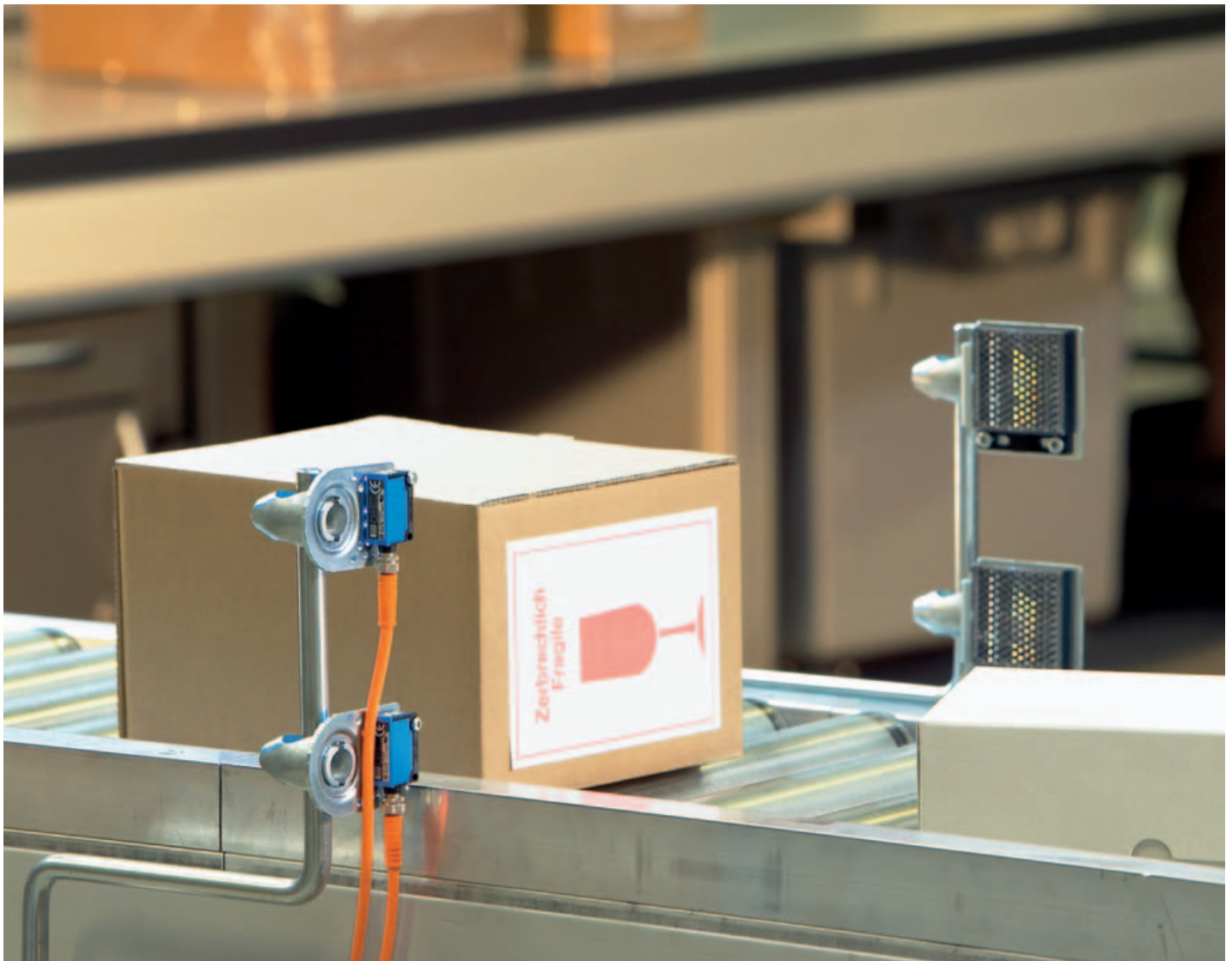

Scanning distance
2 ... 500 mm

Photoelectric proximity switch

- With background suppression (BGS), consequently reliable detection of dark objects in front of a light background
- Scanning distance adjustable via potentiometer
- Red light as alignment aid
- Optionally with off delay $t_{OFF} = 0 \dots 100 \text{ ms}$



Dimensional drawing

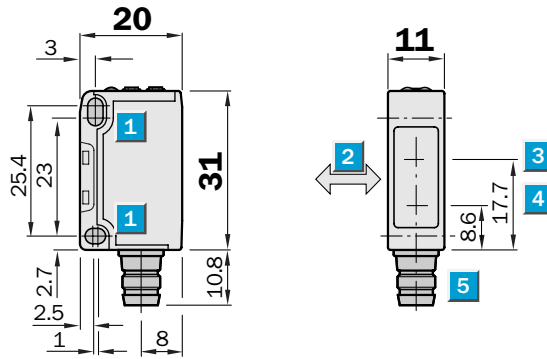

Adjustments possible

WTB140-N132	WTB140-N122
WTB140-N330	WTB140-N420
WTB140-N430	WTB140-P122
WTB140-P132	WTB140-P420
WTB140-P330	
WTB140-P430	

- 1 Mounting hole $\varnothing 3.2 \text{ mm}$ for M3
- 2 Standard direction of the material to be scanned
- 3 Optics center, receiver
- 4 Optics center, transmitter
- 5 Connector
- 6 Green LED indicator: light reception with operating reserve >1.1
- 7 Orange LED indicator: switching output active
- 8 Scanning distance control (5 turns)
- 9 Light/dark rotary switch:
L = light switching, D = dark switching
- 10 OFD, selector switch (270°) off delay t_{OFF} ;
 $t = 0 \text{ s (OFF)} \dots 0.1 \text{ s}$

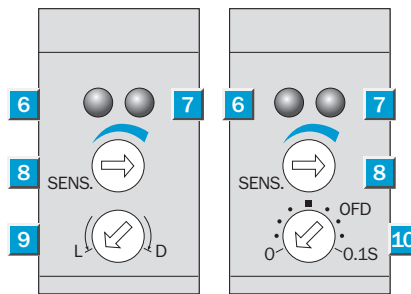

Connection type

WTB140-N330	WTB140-N420	WTB140-N122	WTB140-N132	WTB140-N430
WTB140-P330	WTB140-P420	WTB140-P122	WTB140-P132	WTB140-P430

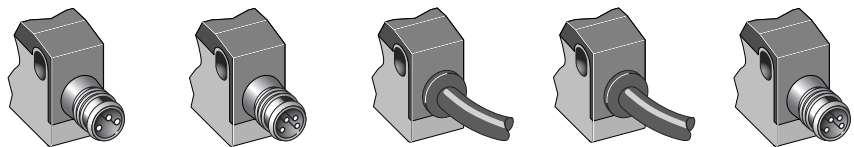

M8, 3-pin	M8, 4-pin	4 x 0.18 mm ²	3 x 0.18 mm ²	M8, 4-pin
-----------	-----------	--------------------------	--------------------------	-----------

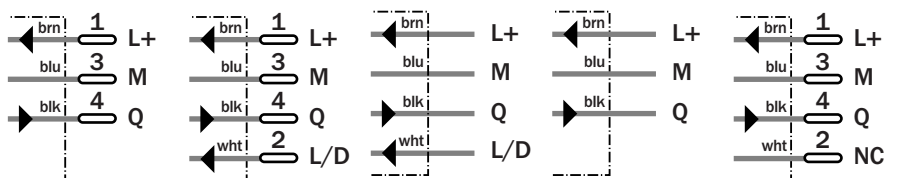

See chapter Accessories

Connector, M8, 3-pin
Connector, M8, 4-pin
Mounting systems

Technical specifications		WTB140-	N122	N132	N330	N420	N430	P122	P132	P330	P420	P430
Scanning distance typ. max.	2 ... 500 mm ¹⁾											
Operating distance	15 ... 500 mm ¹⁾											
Adjustment of operating distance	Potentiometer, 5 revolutions											
Light source, light type	LED, Red light, 680 nm ²⁾											
Light spot diameter	Approx. 15 mm at 200 mm distance											
Angle of dispersion	Approx. 4.3 °											
Supply voltage V _s	DC 10 ... 30 V ³⁾											
Ripple	± 10 % ⁴⁾											
Power consumption	≤ 30 mA ⁵⁾											
Switching outputs	NPN: open collector: Q											
	PNP: open collector: Q											
Switching mode	Light-/dark-switching via L/D control cable											
	Light-/dark-switching via rotary switch											
Signal voltage PNP HIGH / LOW	V _s - 1.8 V / approx. 0 V											
Signal voltage NPN HIGH / LOW	Approx. V _s / < 1.8 V											
Output current I _a max	100 mA											
Response time	≤ 0.5 ms ⁶⁾											
Switching frequency	1,000 Hz ⁷⁾											
Time delay	Selectable: 0 ... 100 ms											
Time type	t _{OFF} (off delay)											
Connection type	Cable, PVC, 2 m ⁸⁾											
	Connector, M8, 3-pin											
	Connector, M8, 4-pin											
VDE protection class	□ ⁹⁾											
Circuit protection	V _s connections reverse-polarity protected / In-/outputs short-circuit protected / Interference suppression / Outputs overcurrent and short-circuit protected											
Enclosure rating	IP 67											
Ambient temperature operation	-25 °C ... +55 °C											
Ambient temperature storage	-40 °C ... +70 °C											
Weight	Approx. 53 g											
	Approx. 9 g											
Housing material	PBT, PC											

¹⁾ Object with 90% remission (based on standard white to DIN 5033). Scanning distance control set to MAX

²⁾ Average service life 100,000 h at

T_a = +25°C

³⁾ Limit values, operation in short-circuit protected network max. 8 A

⁴⁾ may not exceed or fall short of

V_s tolerances

⁵⁾ without load

⁶⁾ Signal transit time with resistive load

⁷⁾ with light/dark ratio 1:1

⁸⁾ do not bend below 0 °C

⁹⁾ Reference voltage 50 V DC

Scanning distance

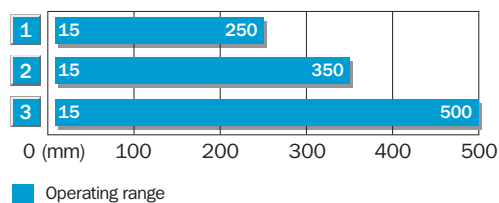

- 1 Scanning range on black, 6 % remission
- 2 Scanning range on gray, 18 % remission
- 3 Scanning range on white, 90 % remission

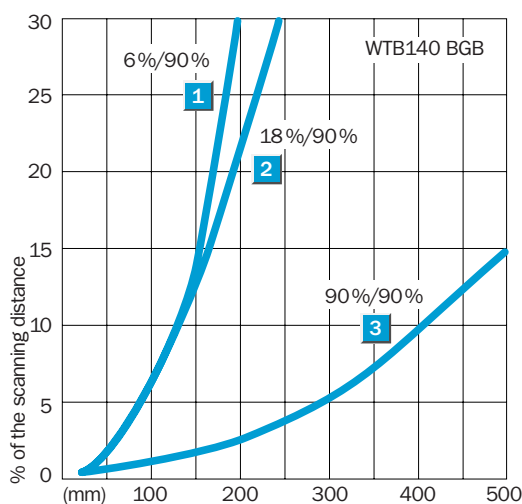

Ordering information

Type	Order no.
WTB140-N122	6 012 628
WTB140-N132	6 012 636
WTB140-N330	6 012 638
WTB140-N420	6 012 631
WTB140-N430	6 012 639
WTB140-P122	6 012 632
WTB140-P132	6 012 640
WTB140-P330	6 012 642
WTB140-P420	6 012 635
WTB140-P430	6 012 643



Scanning distance
0 ... 1,000 mm
Photoelectric proximity switch

- Energetic photoelectric switch for standard applications
- Adjustable switching point
- Red light as alignment aid
- LED indicator: operating reserve

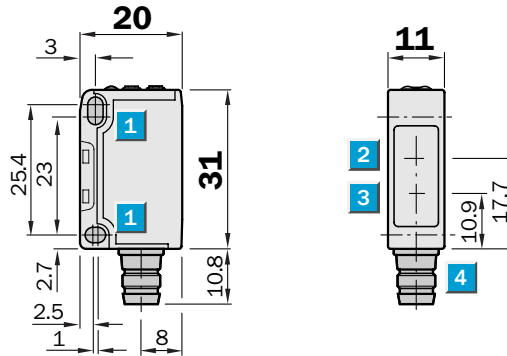
Dimensional drawing

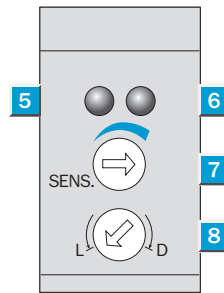

Adjustments possible



- 1 Mounting hole \varnothing 3.2 mm for M3
- 2 Optics center, receiver
- 3 Optics center, transmitter
- 4 Connector
- 5 Green LED indicator: light reception with operating reserve >1.1 and <0.9
- 6 Orange LED indicator: switching output active
- 7 Sensitivity setting (270 °)
- 8 Light/dark rotary switch: L = light switching, D = dark switching



Connection type

WTE140-2N330	WTE140-2N430	WTE140-2N132
WTE140-2P330	WTE140-2P430	WTE140-2P132

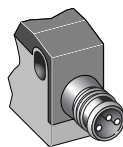

M8, 3-pin

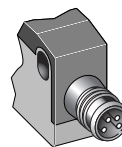
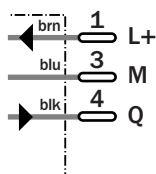

M8, 4-pin

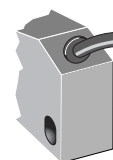
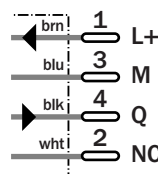

3 x 0.18 mm²

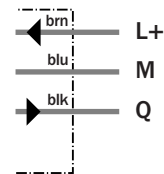

See chapter Accessories

- Connector, M8, 3-pin
- Connector, M8, 4-pin
- Mounting systems

Technical specifications		WTE140-2	N132	N330	N430	P132	P330	P430				
Scanning distance typ. max.	0 ... 1,000 mm ¹⁾											
Operating distance	0 ... 800 mm ¹⁾											
Adjustment of operating distance	Potentiometer											
Light source, light type	LED, Red light, 680 nm ²⁾											
Light spot diameter	Approx. 50 mm at 300 mm distance											
Angle of dispersion	Approx. 9.6 °											
Supply voltage V _s	DC 10 ... 30 V ³⁾											
Ripple	± 10 % ⁴⁾											
Power consumption	≤ 30 mA ⁵⁾											
Switching outputs	NPN: open collector: Q											
	PNP: open collector: Q											
Switching mode	Light-/dark-switching via rotary switch											
Signal voltage PNP HIGH / LOW	V _s - 1.8 V / approx. 0 V											
Signal voltage NPN HIGH / LOW	Approx. V _s / < 1.8 V											
Output current I _a max	100 mA											
Response time	≤ 0.5 ms ⁶⁾											
Switching frequency	1,000 Hz ⁷⁾											
Connection type	Cable, PVC, 2 m ⁸⁾											
	Connector, M8, 3-pin											
	Connector, M8, 4-pin											
VDE protection class	□ ⁹⁾											
Circuit protection	V _s connections reverse-polarity protected / In-/outputs short-circuit protected / Interference suppression / Outputs overcurrent and short-circuit protected											
Enclosure rating	IP 67											
Ambient temperature operation	-25 °C ... +55 °C											
Ambient temperature storage	-40 °C ... +70 °C											
Weight	Approx. 53 g											
	Approx. 9 g											
Housing material	PBT, PC											

¹⁾ Object with 90% remission (based on standard white to DIN 5033) ²⁾ Average service life 100,000 h at T_a = +25°C
³⁾ Limit values, operation in short-circuit protected network max. 8 A ⁴⁾ may not exceed or fall short of V_s tolerances
⁵⁾ without load ⁶⁾ Signal transit time with resistive load
⁷⁾ with light/dark ratio 1:1 ⁸⁾ do not bend below 0 °C
⁹⁾ Reference voltage 50 V DC

Scanning distance

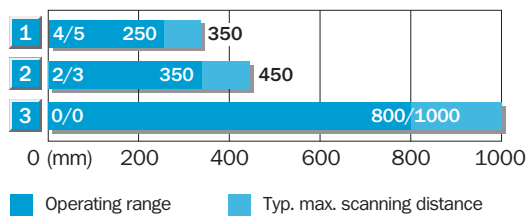

- 1 Scanning range on black, 6 % reflectance
- 2 Scanning range on gray, 18 % reflectance
- 3 Scanning range on white, 90 % reflectance

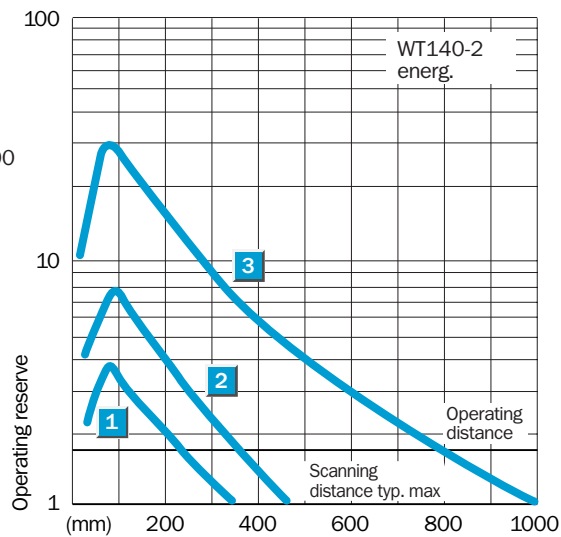

Ordering information	
Type	Order no.
WTE140-2N132	6 024 800
WTE140-2N330	6 024 802
WTE140-2N430	6 024 803
WTE140-2P132	6 024 804
WTE140-2P330	6 024 806
WTE140-2P430	6 024 807

Photoelectric reflex switch, WL140-2, red light - DC

Scanning range
0.01 ... 6.5 m

Photoelectric reflex switch

- Polarisation filter for detection of objects with shiny surfaces
- Also suitable for "Diamond Grade" reflective tape
- Red light as alignment aid
- LED indicator: operating reserve

Dimensional drawing

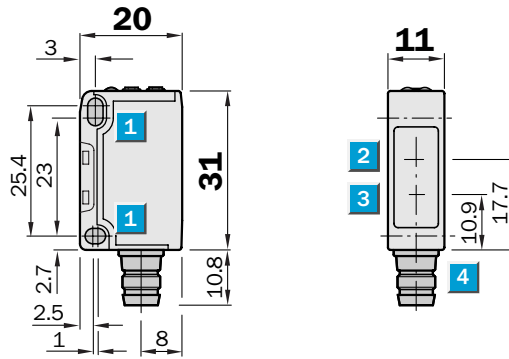

Adjustments possible

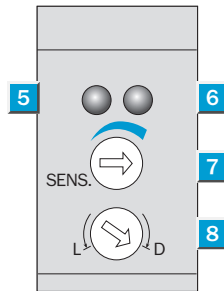

- 1 Mounting hole \varnothing 3.2 mm for M3
- 2 Optics center, receiver
- 3 Optics center, transmitter
- 4 Connector
- 5 Green LED indicator: light reception with operating reserve >1.1 and <0.9
- 6 Orange LED indicator: switching output active
- 7 Sensitivity setting (270 °)
- 8 Light/dark rotary switch: L = light switching, D = dark switching



Connection type

WL140-2N330	WL140-2N430	WL140-2N132
WL140-2P330	WL140-2P430	WL140-2P132

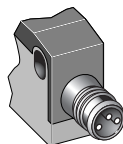

M8, 3-pin

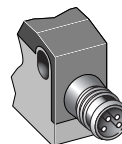
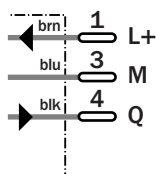

M8, 4-pin

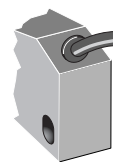
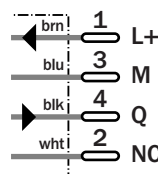

3 x 0.18 mm²

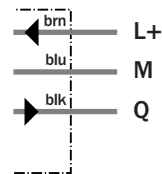

See chapter Accessories

- Connector, M8, 3-pin
- Connector, M8, 4-pin
- Mounting systems
- Reflectors *)

*) Reflector P45 included with delivery

Technical specifications		WL140-2	N132	N330	N430	P132	P330	P430				
Scanning range typ. max.	0.01 ... 6.5 m											
Scanning range, recommended	0.01 ... 5 m											
Relating to	Reflector PL 80 A											
Sensitivity adjustment	Potentiometer											
Light source, light type	LED, Red light, 680 nm ¹⁾											
Light spot diameter	Approx. 250 mm at 2.5 m distance											
Angle of dispersion	Approx. 5.8 °											
Polarisation filter	✓											
Supply voltage V_s	DC 10 ... 30 V ²⁾											
Ripple	± 10 % ³⁾											
Power consumption	≤ 30 mA ⁴⁾											
Switching outputs	NPN: open collector: Q											
	PNP: open collector: Q											
Switching mode	Light-/dark-switching via rotary switch											
Signal voltage PNP HIGH / LOW	V _s - 1.8 V / approx. 0 V											
Signal voltage NPN HIGH / LOW	Approx. V _s / < 1.8 V											
Output current I _a max	100 mA											
Response time	≤ 0.5 ms ⁵⁾											
Switching frequency	1,000 Hz ⁶⁾											
Connection type	Cable, PVC, 2 m ⁷⁾											
	Connector, M8, 3-pin											
	Connector, M8, 4-pin											
VDE protection class	□ ⁸⁾											
Circuit protection	V _s connections reverse-polarity protected / In-/outputs short-circuit protected / Interference suppression / Outputs overcurrent and short-circuit protected											
Enclosure rating	IP 67											
Ambient temperature operation	-25 °C ... +55 °C											
Ambient temperature storage	-40 °C ... +70 °C											
Weight	Approx. 53 g											
	Approx. 9 g											
Housing material	PBT, PMMA											

¹⁾ Average service life 100,000 h at T_a = +25 °C

²⁾ Limit values, operation in short-circuit

protected network max. 8 A
³⁾ may not exceed or fall short of

V_s tolerances
⁴⁾ without load
⁵⁾ Signal transit time with resistive load

⁶⁾ with light/dark ratio 1:1
⁷⁾ do not bend below 0 °C
⁸⁾ Reference voltage 50 V DC

Scanning range and operating reserve

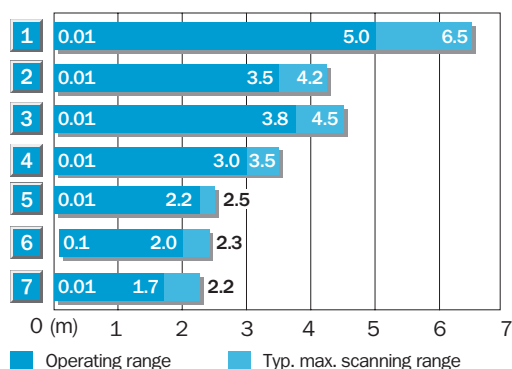

Reflector type	Operating range
1 PL 80 A	0.01 ... 5.0 m
2 P 250	0.01 ... 3.5 m
3 PL 50 A/PL 40 A	0.01 ... 3.8 m
4 PL 30 A/PL 31 A	0.01 ... 3.0 m
5 PL 20 A	0.01 ... 2.2 m
6 Reflective tape Diamond Grade	0.1 ... 2.0 m (100 x 100 mm ²)
7 P 45	0.01 ... 1.7 m

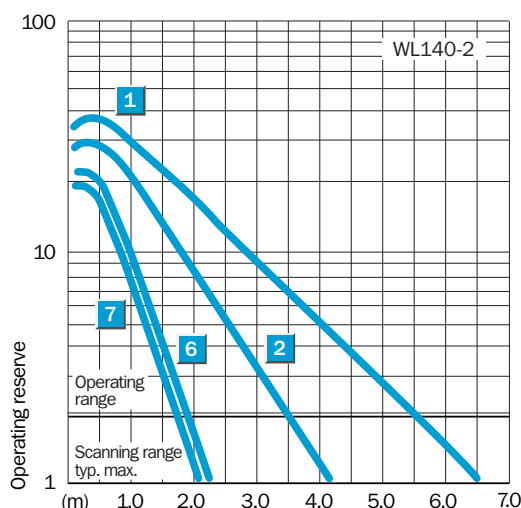

Ordering information	
Type	Order no.
WL140-2N132	6 024 792
WL140-2N330	6 024 794
WL140-2N430	6 024 795
WL140-2P132	6 024 796
WL140-2P330	6 024 798
WL140-2P430	6 024 799



Scanning range
0 ... 16 m

Through-beam photoelectric switch

- Polarisation filter (accessories), consequently no mutual interference when mounted in pairs
- Slotted masks (accessories) for detecting small parts or positioning jobs
- Sensitivity adjustable
- Red light as alignment aid
- LED indicator: operating reserve

Dimensional drawing

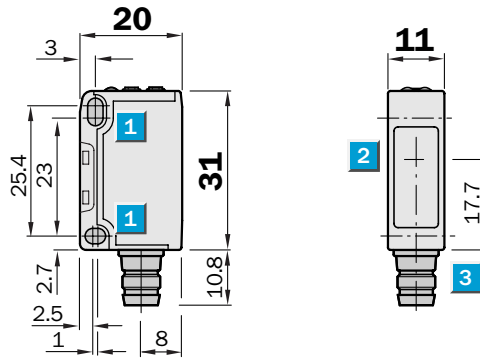

Adjustments possible

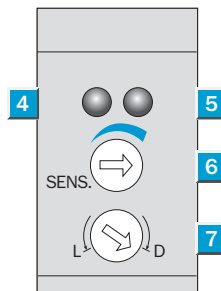

- 1 Mounting hole \varnothing 3.2 mm for M3
- 2 Optics center transmitter, WS140-2
Optics receiver transmitter, WE140-2
- 3 Connector
- 4 Green LED indicator: light reception with operating reserve > 1.1 and < 0.9 (WE140-2)
- 5 Orange LED indicator: Switching output active
- 6 Sensitivity setting (270° , WE140-2)
- 7 Light/dark rotary switch: L = light switching, D = dark switching (WE140-2)

WS/WE140-2 mounting in pairs

No mutual interference thanks to use of polarisation filter tip adapters BL-140-POLF e.g.

- Pair 1: BL-140-POLF with polarisation level
- Pair 2: BL-140-POLF with polarisation level

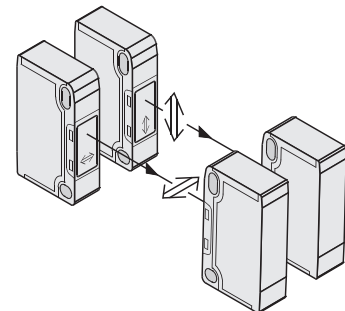

Connection type

WS/WE140-2N330
WS/WE140-2P330

WS/WE140-2N430
WS/WE140-2P430

WS/WE140-2N132
WS/WE140-2P132

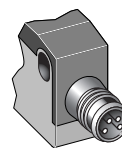
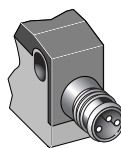

Sender M8, 3-pin

M8, 4-pin

2 x 0.18 mm²

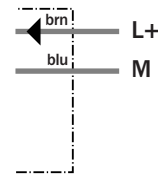
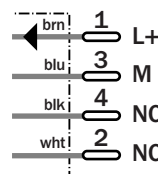
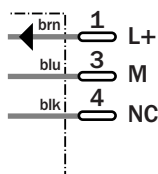

Receiver M8, 3-pin

M8, 4-pin

3 x 0.18 mm²

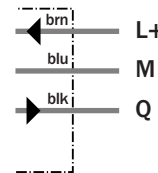
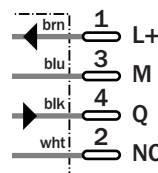
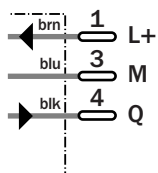

See chapter Accessories

- Connector, M8, 3-pin
- Connector, M8, 4-pin
- Masks
- Mounting systems
- Polarisation filters

Technical specifications		WS/WE140-2	N132	N330	N430	P132	P330	P430				
Scanning range typ. max.	0 ... 16 m											
Scanning range, recommended	0 ... 13 m											
Sensitivity adjustment	Potentiometer											
Light source, light type	LED, Red light, 680 nm ¹⁾											
Light spot diameter	Approx. 1700 mm at 13 m distance											
Angle of dispersion	Approx. 7.6 °											
Angle of reception	Approx. 15 °											
Supply voltage V_s	DC 10 ... 30 V ²⁾											
Ripple	± 10 % ³⁾											
Power consumption, sender	≤ 15 mA ⁴⁾											
Power consumption, receiver	≤ 20 mA ⁴⁾											
Switching outputs	NPN: open collector: Q											
	PNP: open collector: Q											
Switching mode	Light-/dark-switching via rotary switch											
Signal voltage PNP HIGH / LOW	V _s - 1.8 V / approx. 0 V											
Signal voltage NPN HIGH / LOW	Approx. V _s / < 1.8 V											
Output current I _a max	100 mA											
Response time	≤ 0.5 ms ⁵⁾											
Switching frequency	1,000 Hz ⁶⁾											
Connection type	Cable, PVC, 2 m ⁷⁾											
	Connector, M8, 3-pin											
	Connector, M8, 4-pin											
VDE protection class	□ ⁸⁾											
Circuit protection	V _s connections reverse-polarity protected / In-/outputs short-circuit protected (only WE140-2) / Interference suppression (only WE140-2) / Outputs overcurrent and short-circuit protected (only WE140-2)											
Enclosure rating	IP 67											
Ambient temperature operation	-25 °C ... +55 °C											
Ambient temperature storage	-40 °C ... +70 °C											
Weight	Approx. 53 g											
	Approx. 9 g											
Housing material	PBT, PC											

¹⁾ Average service life 100,000 h at T_a = +25 °C
²⁾ Limit values, operation in short-circuit

protected network max. 8 A
³⁾ may not exceed or fall short of

V_s tolerances
⁴⁾ without load
⁵⁾ Signal transit time with resistive load

⁶⁾ with light/dark ratio 1:1
⁷⁾ do not bend below 0 °C
⁸⁾ Reference voltage 50 V DC

Scanning range and operating reserve

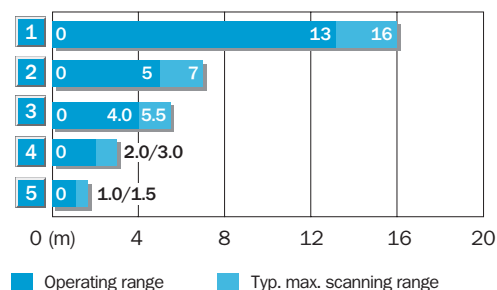

Scanning range reduction when slotted masks are used

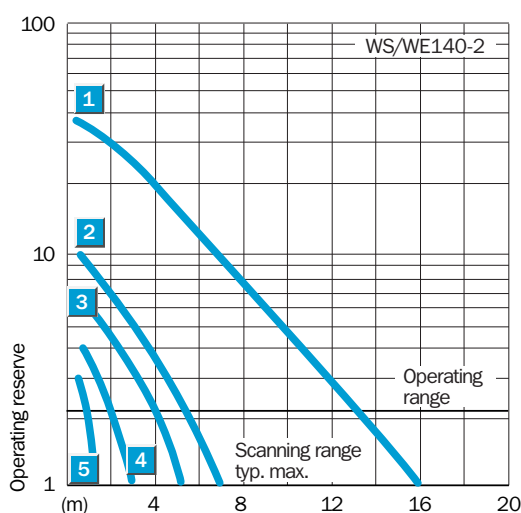

1	Without masks/polarizing filter
2	With polarizing filter tip adapter
3	With slotted mask, width 2.0 mm
4	With slotted mask, width 1.0 mm
5	With slotted mask, width 0.5 mm



Ordering information

Type	Order no.
WS/WE140-2N132	6 024 784
WS/WE140-2N330	6 024 786
WS/WE140-2N430	6 024 787
WS/WE140-2P132	6 024 788
WS/WE140-2P330	6 024 790
WS/WE140-2P430	6 024 791

W 150: Miniature photoelectric switch series with fully integrated electronics

	Photoelectric proximity switches, BGS
	Photoelectric proximity switches, energetic
	Photoelectric reflex switches

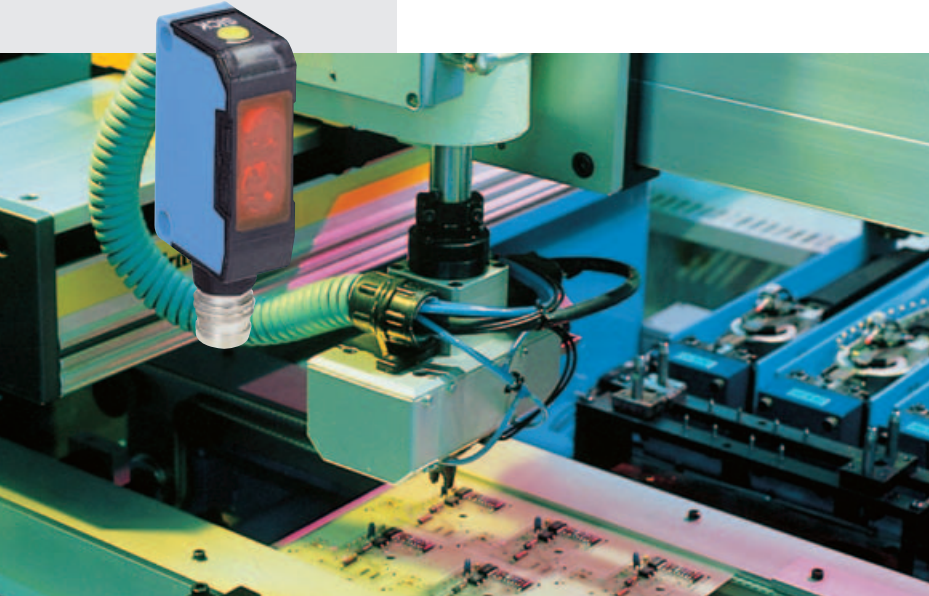

The optical systems of the W 150 series and their scanning ranges:

- WS/WE 150 through-beam photoelectric switch: 4 m, slotted masks available as accessories,
- WL 150 photoelectric reflex switch: 2 m (PL 80 A), with polarising filter,
- WL 150 photoelectric reflex switch with enhanced sensitivity: especially suitable for detecting transparent objects such as glass and film,
- WT 150 photoelectric proximity switch, energetic: scanning distance 200 mm (90 % remission), for standard scanning tasks. With background suppression: scanning distance 100 mm on white, adjustable; for reliable operation in applications with background interference.

Through-beam photoelectric switches

Despite their miniature housing, the W 150 photoelectric switches have exactly the same system characteristics and features as standard photoelectric switches. They are especially characterised by their large scanning ranges. W 150 units are ideal for use at locations where installation space is limited.

They are, therefore, particularly suitable for the following areas of application:

- electronic component and printed circuit board production,
- the packaging and printing industries,
- assembly and handling systems,
- the construction of special-purpose machines.

All electrical and mechanical values meet the standards for low-voltage devices: potentiometer for adjustment, IP 67, $V_s = 10 \dots 30$ V DC, PNP or NPN switching output, M8 plug or cable...

An added bonus: the visible red light of the sender LED facilitates handling.

► WT 150 photoelectric proximity switch with background suppression used to detect wafer cassettes in a clean room through a glass window.

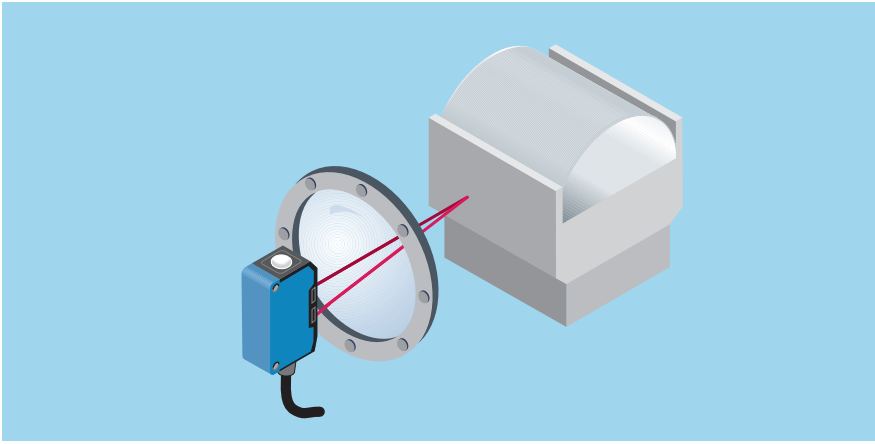

▼ Electronic components are coated with extremely thin transparent films during the production process. A WL 150 photoelectric reflex switch with decreased switching hysteresis is used for reliable detection of the film.

► Minimum space requirements – maximum power: WT 150 miniature photoelectric proximity switch used to check the presence of printed circuit boards in the automated production of electronic components.

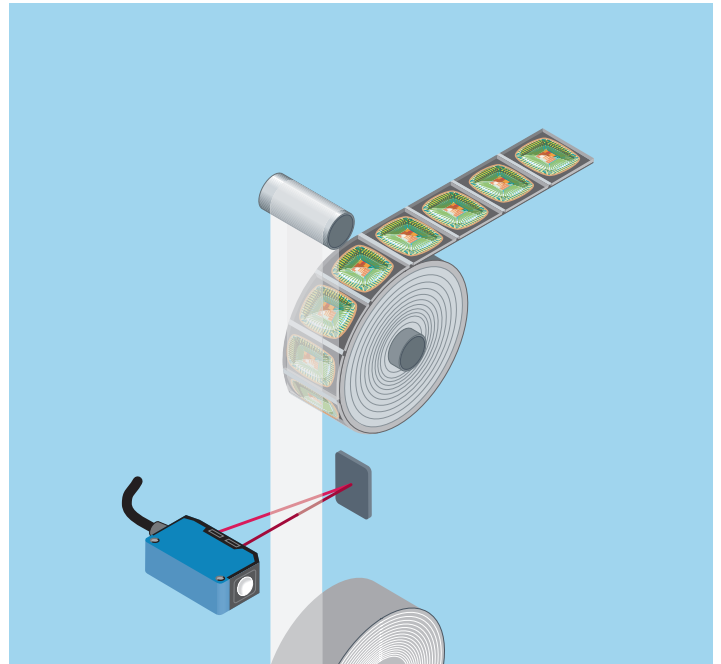
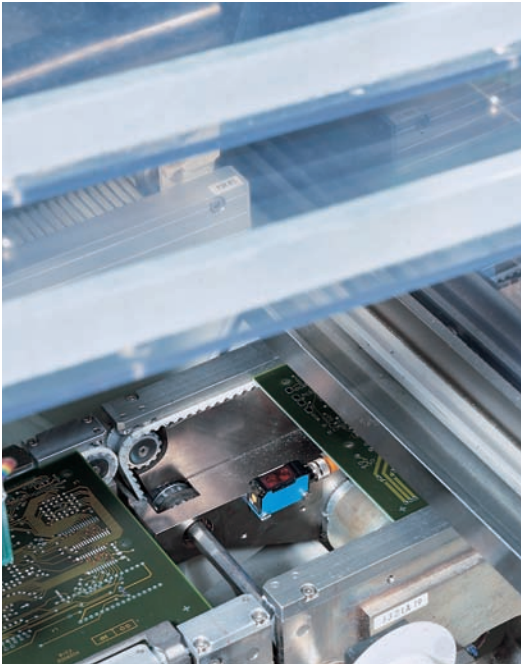

► WT 150 photoelectric proximity switches with background suppression (BGS) used for the reliable detection of bread and confectionery on a conveyor belt – even if the distance between the scanned surface of the object being transported and the surface of the conveyor belt varies slightly.

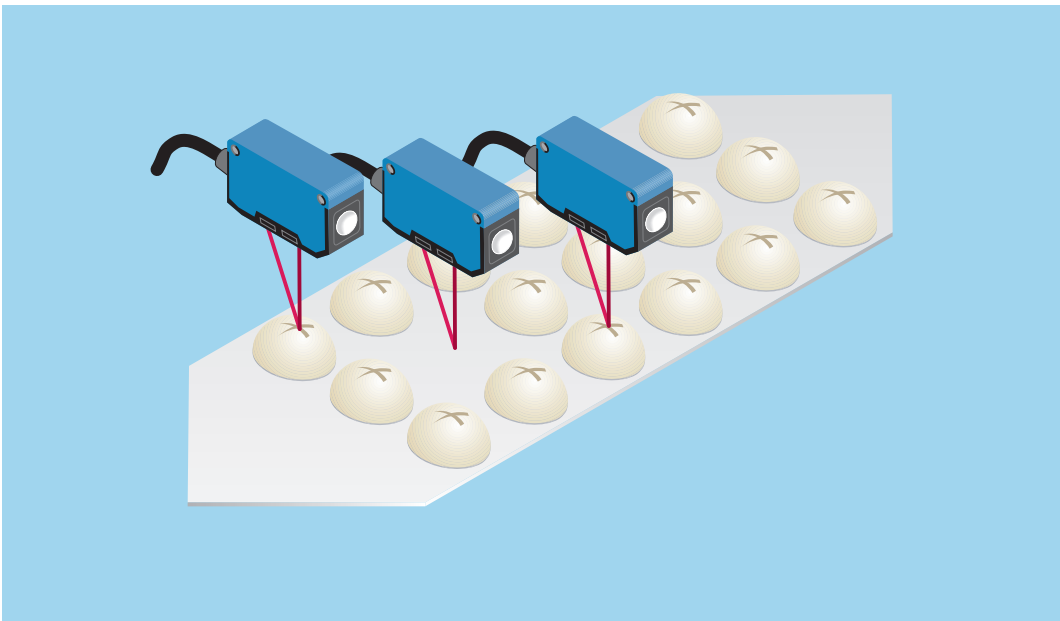

Scanning distance
2 ... 100 mm

Photoelectric proximity switches

- With background suppression for reliable detection of dark objects, even in front of light backgrounds
- Switching point is largely independent of colour and surface of object
- Scanning distance continuously variable, control using 5-turn adjustment screw

Dimensional drawing

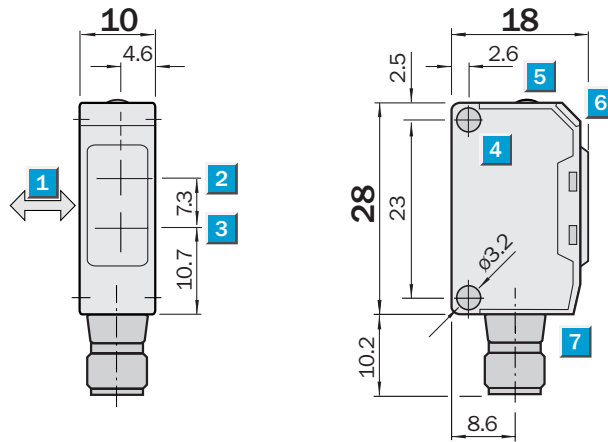

Adjustments possible

WT 150-P 162
WT 150-N 162
WT 150-P 460
WT 150-N 460

- 1 Standard direction of the material being scanned
- 2 Centre of optical axis, receiver
- 3 Centre of optical axis, sender
- 4 Mounting holes \varnothing 3.2 mm
- 5 Scanning distance adjustment (5 rev.)
- 6 LED indicator, red light received \geq switching threshold
- 7 M8 plug – 4-pin or cable

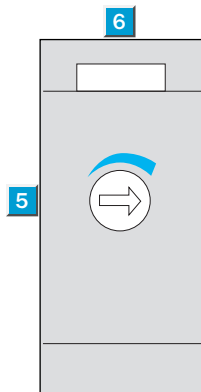

Connection types

WT 150-P 162	WT 150-P 460
WT 150-N 162	WT 150-N 460

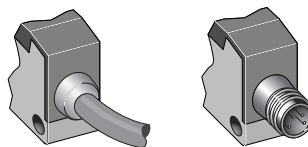

4 x 0.18 mm ²	4-pin, M8
--------------------------	-----------

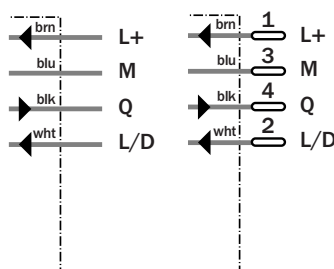

See chapter Accessories
Cables and connectors
Mounting systems *)

*) Mounting brackets Type A included with delivery

Technical data		WT 150-	P 162	P 460	N 162	N 460						
Scanning distance, max. typical	2...100 mm ¹⁾ , adjustable											
Operating distance												
Scanned object with 90% remission	Min. 2...6 mm to max. 10...100 mm											
Scanned object with 18% remission	Min. 2...6 mm to max. 10...80 mm											
Scanned object with 6% remission	Min. 3...6 mm to max. 10...60 mm											
Scanning distance, adjustable	Potentiometer, 5 revolutions											
Background suppression	in % of set scanning distance (see characteristic curve)											
Light source²⁾, light type		LED, visible red light										
Light spot diameter	approx. 4 mm at 40 mm											
Angle of dispersion of sender	approx. 5°											
Supply voltage V_S		10...30 V DC ³⁾										
Residual ripple ⁴⁾	± 10 %											
Current consumption ⁵⁾	≤ 20 mA											
Switching outputs		PNP, open collector: Q										
	NPN, open collector: Q											
Max. output current I _A	100 mA											
Switching mode ⁶⁾		Dark-/light-switching via control cable L/D										
	+ V _S = light-switching											
	0 V = dark-switching											
Response time ⁷⁾	≤ 0.5 ms											
Max. switching frequency ⁸⁾	1000/s											
Connection types												
cable	PVC, 2 m ⁹⁾ ; 4 x 0.18 mm ² , ø 3.5 mm											
plug	M8 – 4-pin											
VDE protection class¹⁰⁾		□										
Circuit protection¹¹⁾		A, B, C, D										
Enclosure rating		IP 67										
Ambient temperature T_A		Operation – 25 °C...+ 55 °C										
	Storage – 40 °C...+ 75 °C											
Weight												
with cable 2 m	Approx. 44 g											
with plug M8 – 4-pin	Approx. 7 g											
Housing material		Housing: ABS/optics: PC										

- 1) Object with 90 % remission (based on standard white to DIN 5033)
- 2) Average service life 100,000 h where T_A = + 25 °C
- 3) Limit values
- 4) May not exceed or fall short of V_S tolerances

- 5) Without load
- 6) Control cable open:
NPN: light-switching
PNP: dark-switching
- 7) Signal transit time with resistive load
- 8) With light/dark ratio 1:1

- 9) Do not bend below 0 °C
- 10) Reference voltage 50 V DC
- 11) A = V_S connections reverse-polarity protected
B = Inputs and outputs reverse-polarity protected

- C = Interference pulse suppression
- D = Outputs overcurrent and short-circuit protected
- 12) Black = 6 % remission
Grey = 18 % remission
White = 90 % remission

Scanning distance

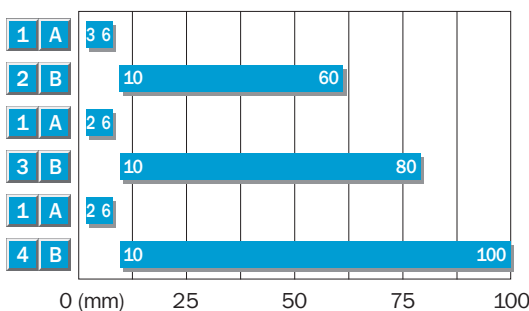

- 1 Scanning distance on black¹²⁾/white background
- 2 Scanning distance on grey¹²⁾/white background
- 3 Scanning distance on white¹²⁾/white background
- A Scanning distance control set to MIN
- B Scanning distance control set to MAX

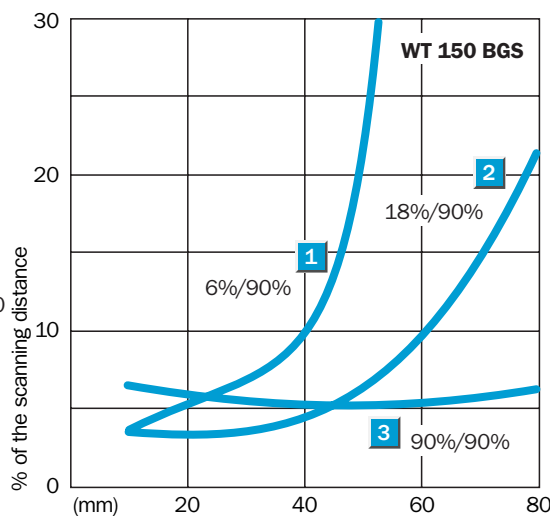

Order information

Type	Order no.
WT 150-P 162	6 011 048
WT 150-P 460	6 011 050
WT 150-N 162	6 011 045
WT 150-N 460	6 011 047

Scanning distance
10 ... 250 mm

Photoelectric proximity switches

- Energetic photoelectric proximity switches
 - for standard applications
 - for simple contrast detection
- Switching point adjustable with sensitivity potentiometer

Dimensional drawing

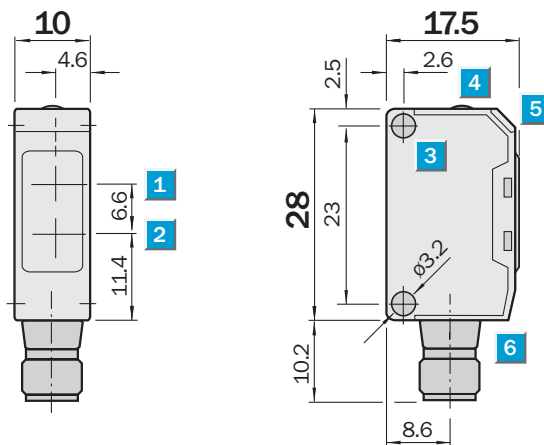

Adjustments possible

WT 150-P 132
WT 150-N 132
WT 150-P 430
WT 150-N 430

- 1 Centre of optical axis, receiver
- 2 Centre of optical axis, sender
- 3 Mounting holes \varnothing 3.2 m
- 4 Sensitivity adjustment 270°
- 5 LED indicator, red:
Light received \geq switching threshold
- 6 M8 plug – 4-pin or connecting cable

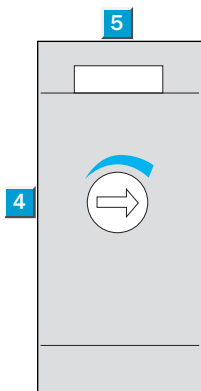

Connection types

WT 150-P 132	WT 150-P 430
WT 150-N 132	WT 150-N 430

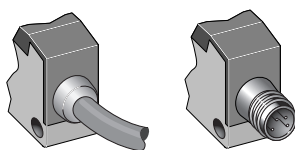

4 x 0.18 mm ²	4-pin, M8
--------------------------	-----------

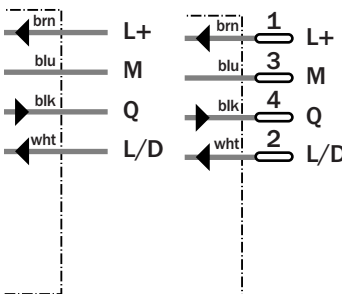

See chapter Accessories

Cables and connectors

Mounting systems ^{*)}

^{*)} Mounting brackets Type A included with delivery

Technical data		WT 150-	P 132	P 430	N 132	N 430
Scanning distance, max. typical	10...250 mm ¹⁾					
Operating distance	10...200 mm ¹⁾					
Sensitivity, adjustable	Potentiometer, 270°					
Light source ²⁾ , light type	LED, red light					
Light spot diameter	Approx. 20 mm at 200 mm					
Angle of dispersion of sender	Approx. 6°					
Supply voltage V _S	10...30 V DC ³⁾					
Residual ripple ⁴⁾	± 10 %					
Current consumption ⁵⁾	≤ 20 mA					
Switching outputs	PNP, open collector: Q					
	NPN, open collector: Q					
Max. output current I _A	100 mA					
Switching mode ⁶⁾	Dark-/light-switching via control cable L/D					
	+ V _S = light-switching					
	0 V = dark-switching					
Response time ⁷⁾	≤ 0.5 ms					
Max. switching frequency ⁸⁾	1000/s					
Connection types						
cable	PVC, 2 m ⁹⁾ ; 4 x 0.18 mm ² , ø 3.5 mm					
plug	M8 – 4-pin					
VDE protection class ¹⁰⁾	□					
Circuit protection ¹¹⁾	A, B, C, D					
Enclosure rating	IP 67					
Ambient temperature T _A	Operation – 25 °C...+ 55 °C					
	Storage – 40 °C...+ 70 °C					
Weight	with cable 2 m					
	with plug M8 – 4-pin					
Housing material	Housing: ABS/optics: PC					

1) Object with 90 % remission (based on standard white to DIN 5033)
 2) Average service life 100,000 h where T_A = + 25 °C
 3) Limit values

4) May not exceed or fall short of V_S tolerances
 5) Without load
 6) Control cable open:
 NPN: light-switching
 PNP: dark-switching

7) Signal transit time with resistive load
 8) With light/dark ratio 1:1
 9) Do not bend below 0 °C
 10) Reference voltage 50 V DC

11) A = V_S connections reverse-polarity protected
 B = Inputs and outputs reverse-polarity protected
 C = Interference pulse suppression
 D = Outputs overcurrent and short-circuit protected

Scanning distance

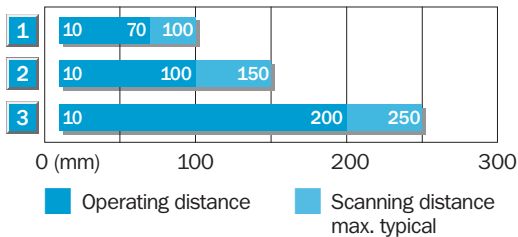

- 1 Scanning distance on black, 6 % remission
- 2 Scanning distance on grey, 18 % remission
- 3 Scanning distance on white, 90 % remission

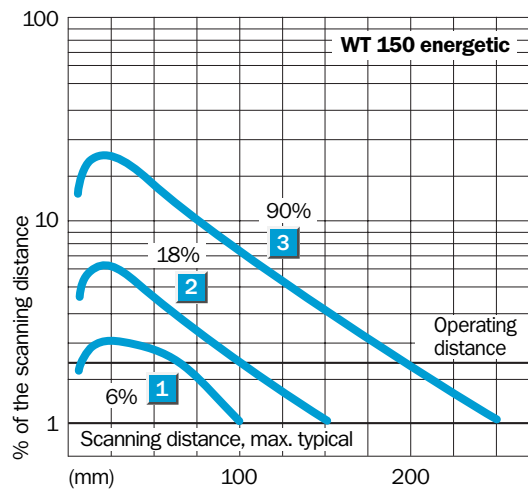

Order information

Type	Order no.
WT 150-P 132	6 011 042
WT 150-N 132	6 011 044
WT 150-P 430	6 011 039
WT 150-N 430	6 011 041

	Scanning range 0.005 ... 2.4 m
Photoelectric reflex switches	

- Polarising filter which also permits reliable detection of objects with shiny surfaces
- Also suitable for "Diamond Grade" reflective tape
- Adjustable sensitivity

Dimensional drawing

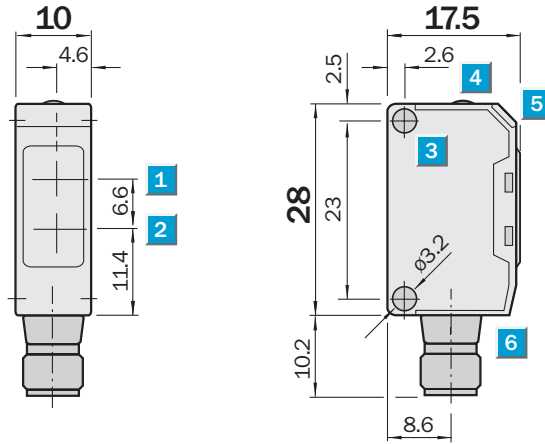

Adjustments possible

WL 150-P 132
WL 150-N 132
WL 150-P 430
WL 150-N 430

- 1** Centre of optical axis, receiver
- 2** Centre of optical axis, sender
- 3** Mounting hole \varnothing 3.2 mm
- 4** Sensitivity adjustment 270°
- 5** LED indicator, red:
Light received \geq switching threshold
- 6** M8 plug – 4-pin or cable

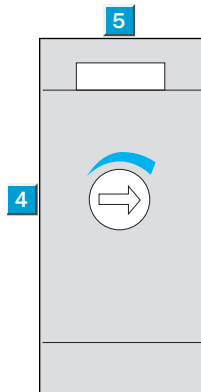

Connection types

WL 150-P 132	WL 150-P 430
WL 150-N 132	WL 150-N 430

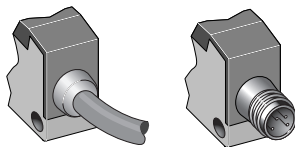

4 x 0.18 mm ²	4-pin, M8
--------------------------	-----------

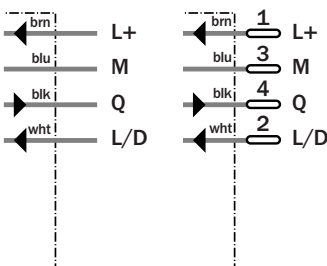

See chapter Accessories
Cables and connectors
Mounting systems ^{*)}
Reflectors ^{**)}

^{*)} Mounting brackets Type A included with delivery
^{**)} PL 20 A included with delivery

Technical data		WL 150-	P 132	P 430	N 132	N 430						
Scanning range, max. typical/ on reflector	0.005...2.4 m/PL 80 A 0.005...1.0 m/PL 20 A (included)											
Operating range	0.01...0.8 m/PL 20 A											
Sensitivity, adjustable	Potentiometer 270°											
Light source¹⁾, light type	LED, visible red light with polarising filter											
Light spot diameter	Approx. 150 mm at 1.5 m											
Angle of dispersion, sender	Approx. 6°											
Supply voltage V_s	10...30 V DC ²⁾											
Residual ripple ³⁾	± 10 %											
Current consumption ⁴⁾	≤ 20 mA											
Switching outputs	PNP, open collector: Q NPN, open collector: Q											
Max. output current I _A	100 mA											
Switching mode ⁵⁾	Dark-/light-switching via control cable L/D + V _s = light-switching 0 V = dark-switching											
Response time ⁶⁾	≤ 0.5 ms											
Max. switching frequency ⁷⁾	1000/s											
Connection types												
cable	PVC, 2 m ⁸⁾ ; 4 x 0.18 mm ² , ø 3.5 mm											
plug	M8 – 4-pin											
VDE protection class⁹⁾	□											
Circuit protection¹⁰⁾	A, B, C, D											
Enclosure rating	IP 67											
Ambient temperature T_A	Operation – 25 °C...+ 55 °C Storage – 40 °C...+ 75 °C											
Weight	with cable (2 m) Approx. 44 g with M8 plug – 4-pin Approx. 7 g											
Housing material	Housing: ABS/optics: PMMA											

1) Average service life 100,000 h where T_A = + 25 °C
2) Limit values
3) May not exceed or fall short of V_s tolerances

4) Without load
5) Control cable open: NPN: light-switching PNP: dark-switching
6) Signal transit time with resistive load

7) With light/dark ratio 1:1
8) Do not bend below 0 °C
9) Reference voltage 50 V DC

10) A = V_s connections reverse-polarity protected
B = Inputs and outputs reverse-polarity protected
C = Interference pulse suppression
D = Outputs overcurrent and short-circuit protected

Scanning range and operating reserve

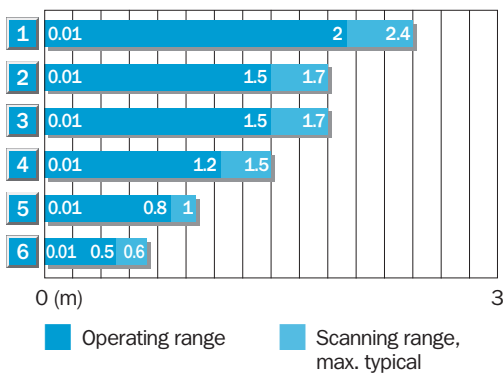

Reflector type	Operating range
1 PL 80 A	0.01...2 m
2 P 250	0.01...1.5 m
3 PL 50 A or PL 40 A	0.01...1.5 m
4 PL 30 A or PL 31 A	0.01...1.2 m
5 PL 20 A	0.01...0.8 m
6 Reflect. tape «Diamond Grade»	0.01...0.5 m

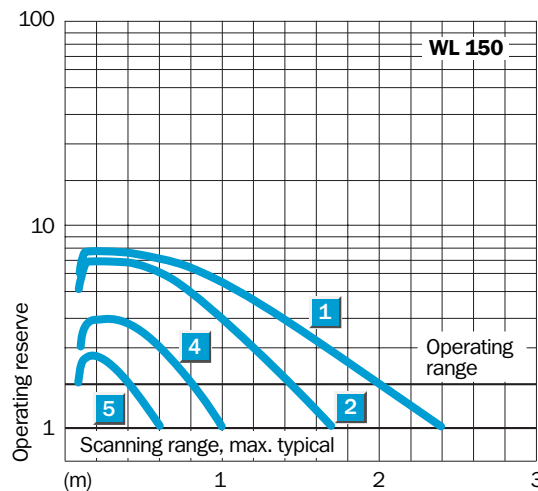

Order information

Type	Order no.
WL 150-P 132	6 011 036
WL 150-P 430	6 011 038
WL 150-N 132	6 011 033
WL 150-N 430	6 011 035

	Scanning range 0.01 ... 0.7 m
Photoelectric reflex switches	

- Ideal for detecting glass, transparent films or small parts
- Detection reliability:
min. attenuation 20 %
min. transmission variation 15 %
- Adjustable sensitivity

Dimensional drawing

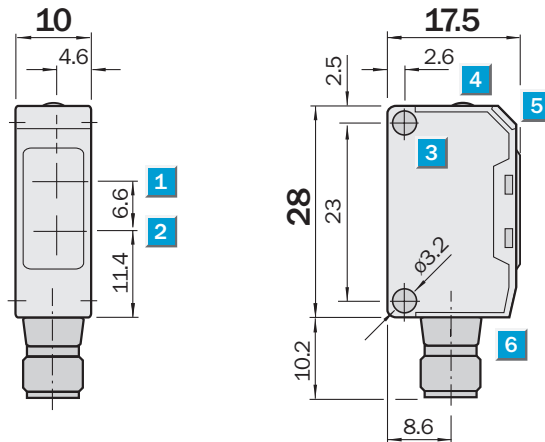

Adjustments possible

WL 150-P 122
WL 150-N 122
WL 150-P 420
WL 150-N 420

- 1 Centre of optical axis, receiver
- 2 Centre of optical axis, sender
- 3 Mounting hole \varnothing 3.2 mm
- 4 Sensitivity adjustment 270°
- 5 LED indicator, red:
Light received \geq switching threshold
- 6 M8 plug – 4-pin or cable

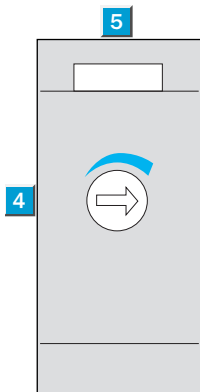

Connection types

WL 150-P 122	WL 150-P 420
WL 150-N 122	WL 150-N 420

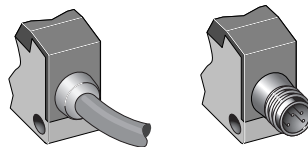

4 x 0.18 mm²

4-pin, M8

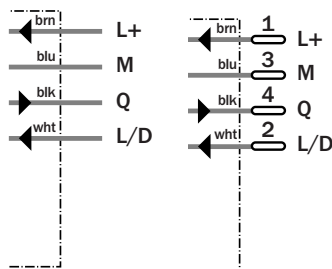

See chapter Accessories

Cables and connectors

Mounting systems ^{*)}

Reflectors ^{**)}

^{*)} Mounting brackets Type A included with delivery

^{**)} PL 20 A included with delivery

Technical data		WL 150-	P 122	P 420	N 122	N 420
Detection of transparent objects						
Attenuation along light beam	min. 20 %					
Attenuation difference along light beam	min. 15 %					
Attenuation difference of object	min. 7.5 %					
Sensitivity, adjustable	Potentiometer, 270°					
Scanning range, max. typical/	0.01...0.70 m/PL 80 A					
on reflector	0.01...0.35 m/PL 20 A					
	(included)					
Operating range	0.01...0.60 m/PL 80 A					
	0.01...0.30 m/PL 20 A					
	Reflective tape: not suitable					
Light source⁴⁾, light type	LED, visible red light					
Light spot diameter	Approx. 40 mm at 0.3 mm					
Angle of dispersion of sender	Approx. 7.5°					
Supply voltage V_S	10...30 V DC ²⁾					
Residual ripple ³⁾	± 10 %					
Current consumption ⁴⁾	≤ 30 mA					
Switching outputs	PNP, open collector: Q					
	NPN, open collector: Q					
Max. output current I _A	100 mA					
Switching mode ⁵⁾	Dark-/light-switching via control cable L/D					
	+ V _S = light-switching					
	0 V = dark-switching					
Response time ⁶⁾	≤ 0.5 ms					
Max. switching frequency ⁷⁾	1000/s					
Connection types						
cable	PVC, 2 m ⁸⁾ ; 4 x 0.18 mm ² , ø 3.5 mm					
plug	M8 – 4-pin					
VDE protection class⁹⁾	□					
Circuit protection¹⁰⁾	A, B, C, D					
Enclosure rating	IP 67					
Ambient temperature T_A	Operation – 25 °C...+ 55 °C					
	Storage – 40 °C...+ 75 °C					
Poids with cable 2 m	Approx. 44 g					
with plug M8 – 4-pin	Approx. 7 g					
Housing material	Housing: ABS/optics: PC					

1) Average service life 100,000 h at T_A = + 25 °C
 2) Limit values
 3) May not exceed or fall short of V_S tolerances

4) Without load
 5) Control cable open:
 NPN: light-switching
 PNP: dark-switching
 6) Signal transit time with resistive load

7) With light/dark ratio 1:1
 8) Do not bend below 0 °C
 9) Reference voltage 50 V DC

10) A = V_S connections reverse-polarity protected
 B = Inputs and outputs reverse-polarity protected
 C = Interference impulse suppression
 D = Outputs overcurrent and short-circuit protected

Scanning range and operating reserve

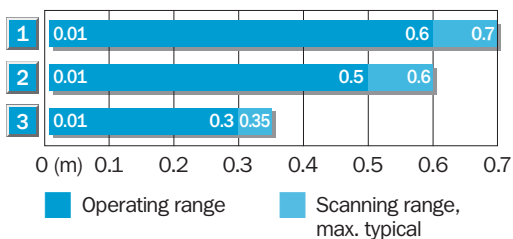

Reflector type	Operating range
1 PL 80 A	0.01...0.6 m
2 P 250	0.01...0.5 m
3 PL 20 A	0.01...0.3 m

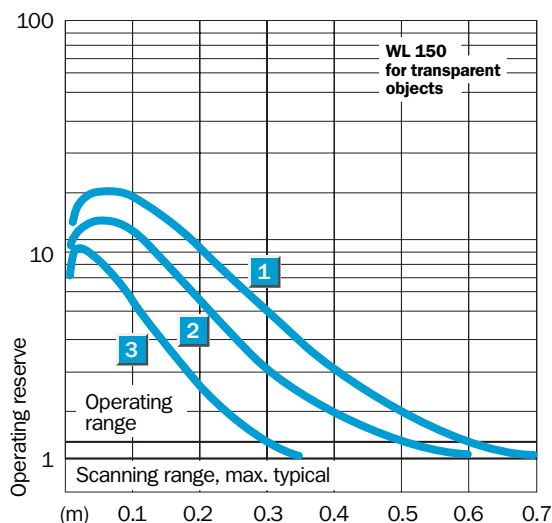

Order information

Type	Order no.
WL 150-P 122	6 020 686
WL 150-P 420	6 020 688
WL 150-N 122	6 020 683
WL 150-N 420	6 020 685

Scanning range
4.4 m

Through-beam photoelectric switches

- Slotted masks 0.5 mm, 1 mm and 2 mm for detection of small parts or for positioning tasks
- Adjustable sensitivity
- Direct voltage supply 10...30 V DC

Dimensional drawing

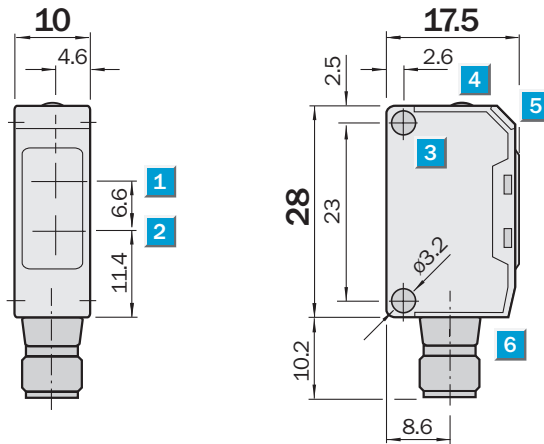

Adjustments possible

WS/WE 150-P132
WS/WE 150-N132
WS/WE 150-P430
WS/WE 150-N430

- 1** Centre of optical axis, sender (WS)
Centre of optical axis, receiver (WE)
- 2** Mounting holes \varnothing 3.2 mm
- 3** Sensitivity adjustment 270° (WE only)
- 4** LED indicator, red (WE only):
Light received \geq switching threshold
- 5** M8 plug – 4-pin or cable

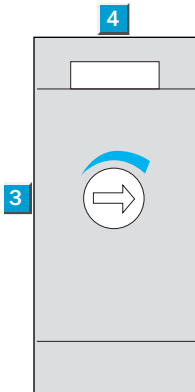

Connection types

WS/WE 150-P132	WS/WE 150-P430
WS/WE 150-N132	WS/WE 150-N430

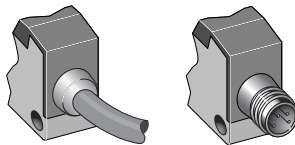

2 x 0.18 mm² 4-pin, M8

See chapter Accessories
Cables and connectors
Mounting systems ^{*)}
Special accessories

^{*)} Mounting brackets Type A included with delivery

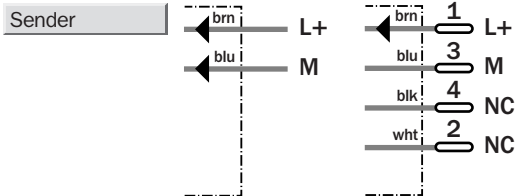

4 x 0.18 mm² 4-pin, M8

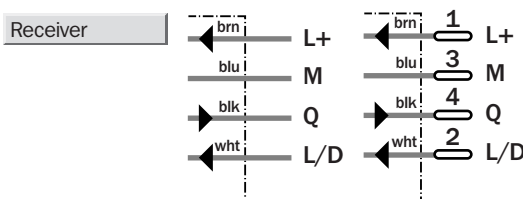

Technical data		WS/WE 150-	P 132	P 430	N 132	N 430						
Scanning range, max. typical	4.4 m											
Operating range	4 m											
Operating range with mask,												
Aperture width 2.0 mm	2.0 m											
Aperture width 1.0 mm	1.0 m											
Aperture width 0.5 mm	0.5 m											
Sensitivity, adjustable	Potentiometer, 270°											
Light source⁴⁾, light type	LED, red light											
Light spot diameter	Approx. 400 mm at 4 mm											
Angle of dispersion of sender	Approx. 6°											
Angle of reception of receiver	Approx. 15°											
Supply voltage V_A	10...30 V DC ²⁾											
Residual ripple ³⁾	± 10 %											
Current consumption ⁴⁾ sender	≤ 15 mA											
receiver	≤ 20 mA											
Switching outputs	PNP, open collector: Q											
	NPN, open collector: Q											
Max. output current I _A	100 mA											
Switching mode ⁵⁾	Dark-/light-switching via control cable L/D											
	+ V _S = light-switching											
	0 V = dark-switching											
Response time ⁶⁾	≤ 0.5 ms											
Max. switching frequency ⁷⁾	1000/s											
Connection types cable	PVC, 2 m ⁸⁾											
sender WS	2 x 0.18 mm ² , ø 3.5 mm											
receiver WE	4 x 0.18 mm ² , ø 3.5 mm											
Plug	M8 – 4-pin											
VDE protection class⁹⁾	□											
Circuit protection¹⁰⁾												
sender	A, B											
receiver	A, B, C, D											
Enclosure rating	IP 67											
Ambient temperature T_A	Operation – 25 °C...+ 55 °C											
	Storage – 40 °C...+ 70 °C											
Weight												
with cable 2 m	Sender: appr. 44 g, receiver: appr. 44 g											
with plug	Sender: appr. 7 g, receiver: appr. 7 g											
Housing material	Housing: ABS/optics: PC											

1) Average service life 100,000 h at T_A = + 25 °C
 2) Limit values
 3) May not exceed or fall short of V_S tolerances
 4) Without load
 5) Control cable open:
 NPN: light-switching
 PNP: dark-switching
 6) Signal transit time with resistive load
 7) With light/dark ratio 1:1
 8) Do not bend below 0 °C
 9) Reference voltage 50 V DC
 10) A = V_S connections reverse-polarity protected
 B = Inputs and outputs reverse-polarity protected
 C = Interference impulse suppression
 D = Outputs overcurrent and short-circuit protected
 11) Order no. includes both sender and receiver!

Scanning range and operating reserve

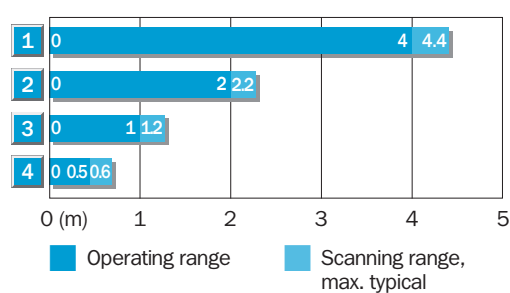

Reduction in scanning range with slotted masks

1	Without slotted mask
2	Mask aperture width 2.0 mm
3	Mask aperture width 1.0 mm
4	Mask aperture width 0.5 mm

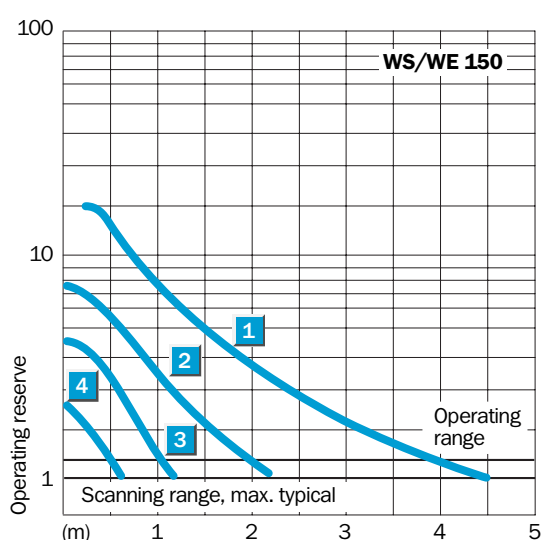

Order information

Type	Order no. ¹¹⁾
WS/WE 150-P 132	6 011 030
WS/WE 150-P 430	6 011 032
WS/WE 150-N 132	6 011 027
WS/WE 150-N 430	6 011 029